

# Citrus information kit

Reprint – information current in 1997



## REPRINT INFORMATION – PLEASE READ!

For updated information please call 13 25 23 or visit the website [www.dpi.qld.gov.au](http://www.dpi.qld.gov.au)

This publication has been reprinted as a digital book without any changes to the content published in 1997. We advise readers to take particular note of the areas most likely to be out-of-date and so requiring further research:

- Chemical recommendations—check with an agronomist or Infopest [www.infopest.qld.gov.au](http://www.infopest.qld.gov.au)
- Financial information—costs and returns listed in this publication are out of date. Please contact an adviser or industry body to assist with identifying more current figures.
- Varieties—new varieties are likely to be available and some older varieties may no longer be recommended. Check with an agronomist, call the Business Information Centre on 13 25 23, visit our website [www.dpi.qld.gov.au](http://www.dpi.qld.gov.au) or contact the industry body.
- Contacts—many of the contact details may have changed and there could be several new contacts available. The industry organisation may be able to assist you to find the information or services you require.
- Organisation names—most government agencies referred to in this publication have had name changes. Contact the Business Information Centre on 13 25 23 or the industry organisation to find out the current name and contact details for these agencies.
- Additional information—many other sources of information are now available for each crop. Contact an agronomist, Business Information Centre on 13 25 23 or the industry organisation for other suggested reading.

Even with these limitations we believe this information kit provides important and valuable information for intending and existing growers.

**This publication was last revised in 1997. The information is not current and the accuracy of the information cannot be guaranteed by the State of Queensland.**

This information has been made available to assist users to identify issues involved in the production of citrus. This information is not to be used or relied upon by users for any purpose which may expose the user or any other person to loss or damage. Users should conduct their own inquiries and rely on their own independent professional advice.

While every care has been taken in preparing this publication, the State of Queensland accepts no responsibility for decisions or actions taken as a result of any data, information, statement or advice, expressed or implied, contained in this publication.



Queensland Government



# *Growing* **THE CROP**

*This section is our recipe for growing and marketing a commercial crop of citrus. To keep this as brief as possible and easy to follow, little explanation is provided with the recommendations. Where more information may help, reference is made to other sections of the kit. Symbols on the left of the page will help you make these links.*



## **Getting the crop started**

**3**

*How to plan the orchard, choose varieties, prepare the land and plant*



## **Managing young trees**

**16**

*Things to do from planting to when the trees start to bear*



## **Managing bearing trees**

**22**

*How to look after bearing trees including fertilising, watering, pruning and pest and disease control*



## **Harvesting and marketing**

**35**

*The steps from harvesting to marketing*

# Some important citrus terms

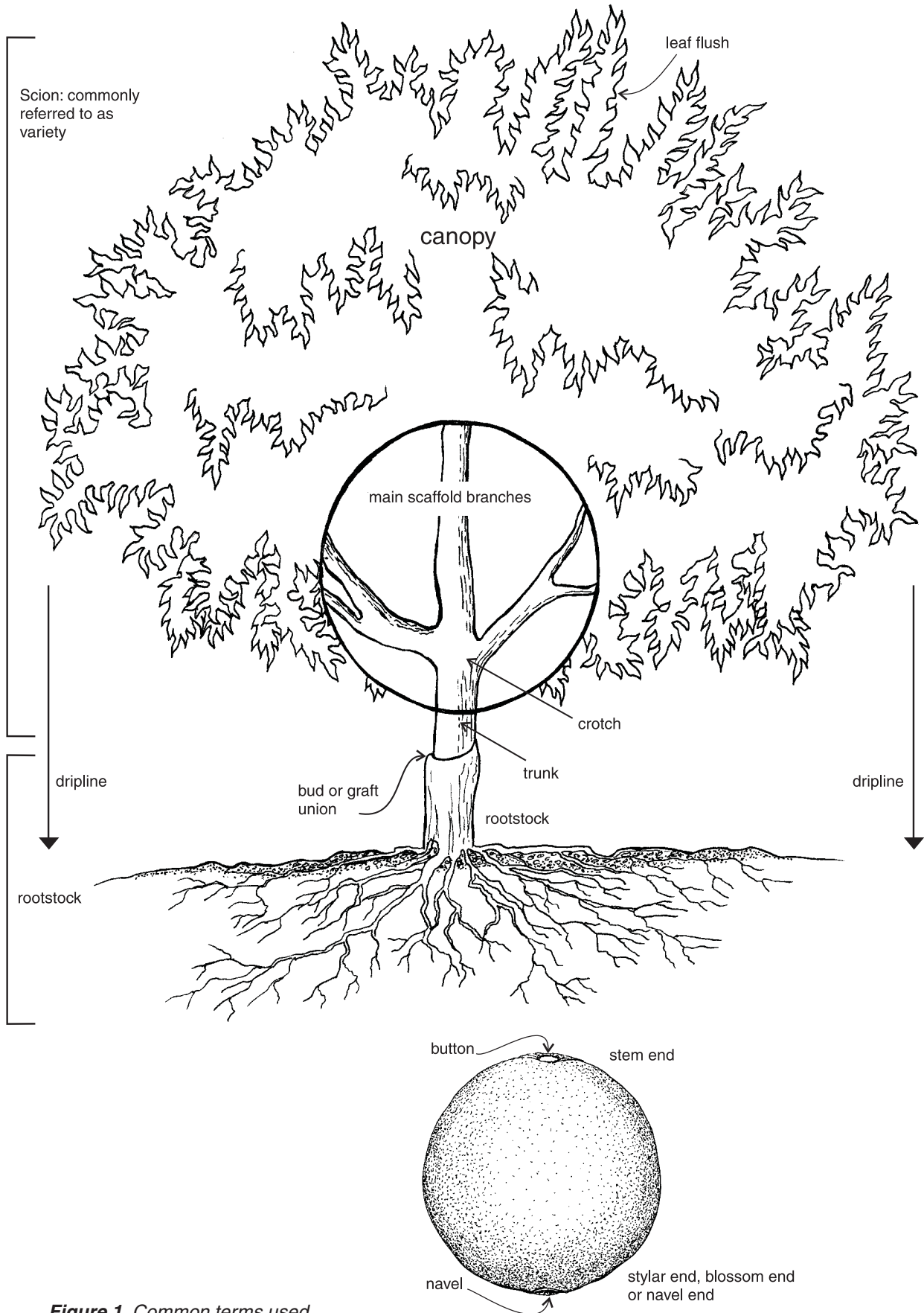


Figure 1. Common terms used



## Getting the crop started

*Setting up an orchard that will be profitable in the long term requires careful planning. Mistakes made at this stage are difficult and costly to correct. There are 14 important steps.*

Plan the orchard layout .....	3
Choose varieties and tree spacing .....	5
Order trees .....	9
Clear the land leaving appropriate windbreaks .....	9
Mark out the rows .....	9
Deep rip along the rows .....	10
Build contour drains/v-drains to control runoff .....	10
Plant windbreak trees .....	12
Do a soil analysis and apply required fertilisers .....	12
Cultivate strips along the tree rows .....	12
Grow a green manure crop in the strips .....	13
Mark out the tree plant sites .....	13
Install the irrigation system .....	13
Plant the trees .....	13



### Plan the orchard layout

Planning the orchard is a complex procedure and it is recommended that you get some expert assistance. This is available free of charge from land conservation extension officers of the Department of Natural Resources.

More detail on the procedure is contained in Section 4 of this kit. Here is a brief overview of what's involved.

First get a map of the intended orchard site and mark on it existing features (roadways, standing timber, gullies, slope direction etc). The procedure is to then develop on it a plan showing access roads,

buildings, windbreaks, tree rows, surface drains to control runoff, dam sites and so on. The aim is to achieve maximum productivity with minimal environmental impact. Important things to consider are:

- **Provision for windbreaks.** These are vital as wind damages fruit and reduces its quality and may cause structural damage to the tree. As the major damaging winds come from the south-east and the west, windbreak protection on at least these sides of the orchard is essential. Use existing stands of timber where possible, otherwise plant windbreaks well before the orchard is established. Seek expert advice on windbreak design from forestry extension officers of the Department of Natural Resources.
- **Surface drains.** Uncontrolled water runoff removes valuable topsoil and exposes roots to desiccation. It may also pool within the orchard causing waterlogging and root rot. Drains are necessary to safely carry water through the orchard. A drainage system normally consists of a diversion drain at the top of the orchard, contour drains or v-drains within the orchard, and stable waterways to carry the water to a dam or watercourse.
- **Slopes.** Slopes of up to 15% are preferred as these are less susceptible to soil erosion, allow flexibility with row layout, and enable tractors and machinery to be operated safely across the slope. Slopes greater than 15% should be avoided, but if used, require specialised design advice.
- **Row direction and length.** Try to run rows in a north-south direction where possible. However, row direction should suit the design needs of the irrigation system. Consult a qualified irrigation designer for assistance. On slopes of up to 15%, rows can be run across the slope or up and down the slope. On slopes above 15%, rows must be run up and down the slope to allow safe machinery operation. Try to get long rows as these are preferred for machinery efficiency. However, breaks in the rows are needed to facilitate efficient harvesting.
- **Watercourses and dams.** Gullies, creeks and depressions should be disturbed as little as possible. Leave a buffer of trees along gullies and creek banks to keep them stable. Do not plant orchard trees where runoff naturally concentrates in gullies or depressions. Professional advice on dam siting and construction should be sought from water field officers of the Department of Natural Resources.
- **Roadways.** It is important to have all-weather access to the orchard for spraying, harvesting and other operations. For this reason, locate access roads on ridgelines wherever possible
- **High density plantings.** Because high density orchards have specialised requirements for irrigation design and pruning, seek advice from an experienced citrus consultant.

An example of how these factors are integrated into an orchard design plan is shown in Figure 2.



Planning orchard layout  
Section 4 page 12

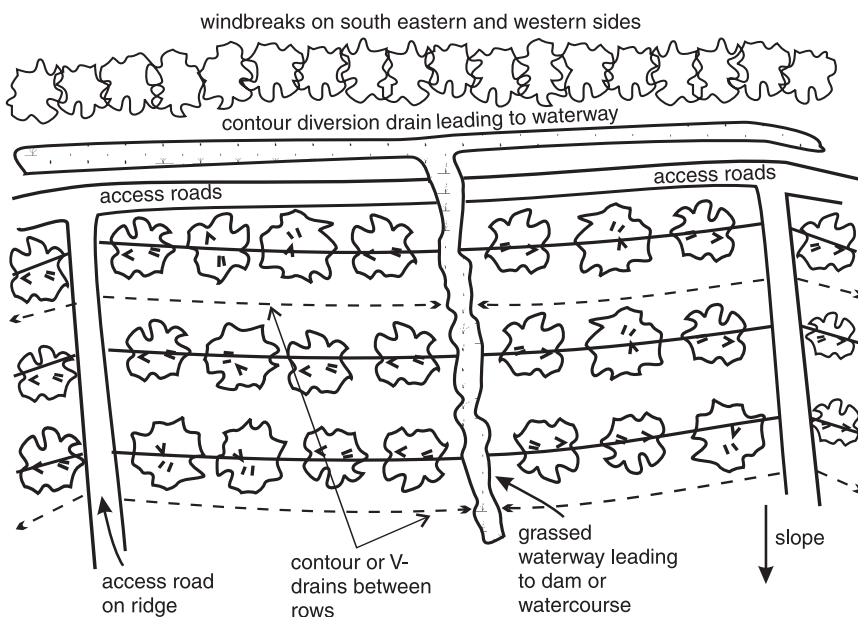


Figure 2. An example of an orchard design plan

## Choose varieties and tree spacing

### Varieties

More than 20 different varieties of citrus are grown commercially in Queensland. The varieties you choose depend firstly on their suitability for your district, and secondly, on what market you are going to target. You need to investigate both in detail before deciding on which varieties to plant. Table 1 is a list of the varieties we suggest you consider. Don't rely solely on the suggestions made here. Also seek opinion from experienced growers, consultants and marketers. Growers investigating the export market should also consult exporters and citrus export organisations.

In a large commercial orchard, choose a number of different varieties to spread harvesting and cash flow over the normal six month harvesting period.

more info



Citrus consultants  
Section 6 page 6

more info



Citrus export organisations  
Section 6 page 8

**Table 1.** Varieties to consider

District	Domestic market	Export market
Coastal areas e.g. Sunshine Coast, Tiaro, Maryborough, Bundaberg, Byfield, Cardwell, Kuranda, Koah	<p><b>Oranges:</b> Washington Navel Joppa Valencia Navelena Navel (trial) Newhall Navel (trial) Fischer Navel (trial)</p> <p><b>Mandarins:</b> Emperor Imperial Success (trial)</p> <p><b>Lemons:</b> Meyer</p> <p><b>Grapefruit:</b> Marsh Oroblanco (trial) Red grapefruit—Henderson, Rio, Star Ruby, Flame, Ruby Red (trial) Pink grapefruit—Thompson Pink (trial)</p> <p><b>Limes:</b> Tahitian lime West Indian lime (North Queensland only)</p>	<p><b>Oranges:</b> Valencia* Navel types*(minor)</p> <p><b>Mandarins:</b> Fremont* Success* Nova*</p>
Inland areas e.g. Central Burnett, Emerald, Gatton, Charters Towers, Mareeba	<p><b>Oranges:</b> Washington Navel Valencia Navelena Navel Newhall Navel Fischer Navel</p> <p><b>Mandarins:</b> Imperial Hickson Ellendale Murcott Success (trial)</p> <p><b>Lemons:</b> Villa Franca Lisbon Eureka Meyer</p> <p><b>Grapefruit:</b> Marsh Oroblanco (trial) Red grapefruit—Henderson, Rio, Star Ruby, Flame, Ruby Red (trial) Pink grapefruit—Thompson Pink (trial)</p> <p><b>Limes:</b> Tahitian lime West Indian lime (North Queensland only)</p>	<p><b>Oranges:</b> Valencia Navel types (minor)</p> <p><b>Mandarins:</b> Hickson Ellendale Murcott Ellenor Nova Sunburst Fremont Clementine (Marisol, de Nules) Success</p> <p><b>Lemons:</b> Lisbon (minor) Eureka (minor)</p> <p><b>Grapefruit:</b> Red grapefruit (trial) Pink grapefruit (trial)</p>

\* Note that it is difficult to produce fruit of required export quality in wetter coastal areas.

Seville oranges, rough lemons, kumquats, calamondins, citrons, lemonades and shaddocks are grown in hobby blocks and home gardens but are not recommended for extensive commercial production.

a key issue



Selecting varieties  
Section 4 page 22



Citrus consultants  
Section 6 page 6

## Rootstocks

All citrus trees, except West Indian limes, are propagated by budding or grafting on to seedling rootstocks. Several rootstocks are used, each of which has specific advantages and disadvantages. Rootstock selection is primarily determined by the planting site and the scion variety.

Table 2 outlines the main rootstocks suggested for each variety. However, decisions regarding the type of rootstock to use should be discussed with an experienced consultant.

**Table 2.** Suggested rootstocks for citrus varieties (read notes at end of table)

Scion variety	Suggested rootstocks where topsoil is well-drained (greater than 75 cm deep) and has not previously grown citrus	Rootstocks to use in replant citrus land or where soil is less well-drained (less than 75 cm deep)
Oranges	Rough lemon Troyer citrange Sweet orange Swingle citrumelo	Troyer citrange Poncirus trifoliata Swingle citrumelo
Ellendale mandarin	Troyer citrange Sweet orange	Troyer citrange Poncirus trifoliata
Murcott mandarin	Rough lemon Cleopatra mandarin Troyer citrange Sweet orange Swingle citrumelo	Troyer citrange Swingle citrumelo
All other mandarins	Cleopatra mandarin Troyer citrange* Sweet orange	Cleopatra mandarin Troyer citrange*
Villa Franca and Lisbon lemons	Rough lemon Troyer citrange	Troyer citrange
Eureka lemon	Rough lemon Frazer (hybrid) Cox (hybrid) Benton	Frazer (hybrid) Cox (hybrid) Benton
Meyer lemons	Rough lemon	None proven. Suggest soil fumigation with either rough lemon or cleopatra mandarin
Grapefruit	Rough lemon Swingle citrumelo	Troyer citrange Swingle citrumelo
Limes	Rough lemon Troyer citrange Poncirus trifoliata	Troyer citrange Poncirus trifoliata

\* Rootstock overgrowth of Imperial mandarin on Troyer citrange can reduce tree life and productivity under some conditions (poor soil, poor watering, overcropping).

### Notes:

- With Troyer citrange, Poncirus trifoliata and Swingle citrumelo, use only propagation material certified free from virus and viroid diseases to avoid reduced tree life and productivity.
- Now that the severe sweet orange strain of tristeza occurs in Queensland, use of sweet orange rootstock may reduce tree life and productivity.



Selecting rootstocks  
Section 4 page 29



## Row and tree spacing

Trees are usually planted in large single variety blocks. Although new work indicates interplanting of varieties may increase fruit set and size, firm recommendations cannot be made at this stage.

Imperial and Navel trees can be grouped on the lowest or coldest sections of the orchard because their crops will be harvested before winter. Plant lemons and varieties which carry fruit through the winter such as Murcott and Valencia in the warmest area of the orchard unless wind machines are available.

Table 3 sets out the common in-row tree spacings for the main varieties. **This assumes a standard row spacing of 7.3 metres.** This allows machinery access for most of the life of the orchard with only some side trimming of older trees required when the canopy interferes with spray application. However, closer in-row tree spacings are now common and are recommended. These closer spacings require the possible removal of every second tree when they grow together and production starts to decline. This is indicated in the table.

The system of closer spacings with tree removal has some significant advantages. It allows more efficient use of limited land and increases yields and cash flow in the early years of the life of the orchard. By concentrating trees in smaller blocks, it also provides more flexibility in the use of land should varieties or rootstocks change. However, if you use closer spacings, it is essential that you understand the need for a higher level of management from about the fifth or sixth year. For example, you must be prepared to remove trees when and if required. If you are unsure about this, plant at the wider spacings.

**Table 3.** Tree spacings (rows spaced at 7.3 metres)

Variety	Tree spacing	Trees per hectare	Tree removal required?
Navel, Valencia and Joppa oranges	3.6	380	Yes
	5.5	249	No
Imperial mandarins	1.8	760	Yes
	3.6	380	Maybe
	5.5	249	No
Ellendale mandarins	2.7	507	Yes
	3.6	380	Yes
	5.5	249	No
Murcott and other mandarins	2.7	570	Yes
	3.6	380	Maybe
	5.5	249	No
Grapefruit and lemons	3.6	380	Maybe
	5.5	249	No

In replant situations or where heavy soils or mounds are being planted, trees may not reach the large sizes on which the above table is based. In these cases, tree removal, where indicated, may not be required.

### **Higher density planting**

For mandarins excluding Ellendale, narrower rows down to 6 metres may be used. Machinery access will become difficult at an earlier age and side trimming will then need to commence. In mature blocks, annual side trimming will be necessary.

### **Very high density planting**

With Imperial and Murcott mandarins, a very close planting alternative is being practised by some growers. This uses 3.6 metres between rows and 1.8 metres between trees within the rows. While it appears to be successful, there is as yet no experience with this system beyond an orchard age of ten years. It also requires a high level of management to maintain good yields and fruit quality. This includes tree pruning and side trimming from about the fifth year. Custom made or modified machinery such as narrow tractors and specialised sprayers are also required.

### **Order trees**

Once you have chosen your varieties and worked out your row and tree spacing, calculate your tree requirements. Then order your trees at least twelve months before intended planting from a specialist citrus nursery. These nurseries have access to the best disease-free strains of citrus available from special budwood and seed schemes

As nursery production of trees is a specialist job, it is not recommended that you try to propagate your own trees. However, if you want to learn more about citrus propagation, read the DPI book *Propagation of citrus in containers*.

### **Clear the land leaving appropriate windbreaks**

Start any clearing at least twelve months prior to planting. First identify and mark strategically placed existing stands of timber to act as perimeter windbreaks. Before clearing, get professional advice from forestry extension officers of the Department of Natural Resources. Also check your local authority for any tree clearing ordinances that may exist. Then clear and stickrake the land where necessary. Stack the timber into windrows for burning. Don't push it into gullies and depressions. Leave gaps in the windrows every 30 metres to allow safe removal of runoff water.

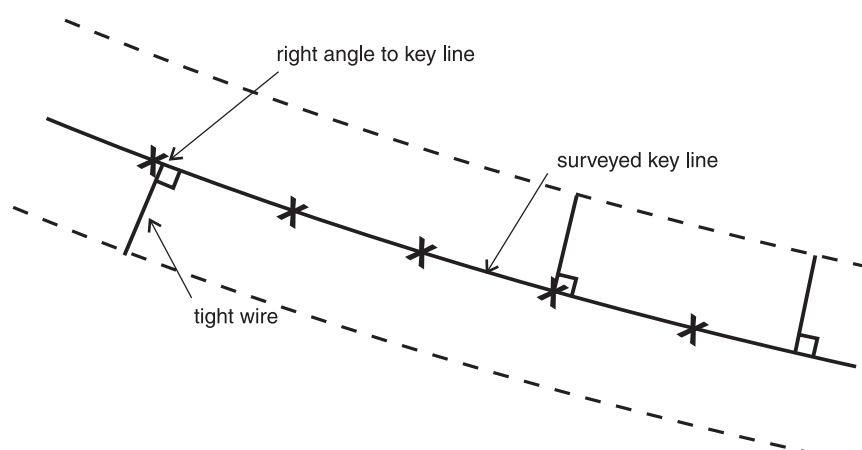
### **Mark out the rows**

On slopes, rows across the slope are marked parallel to a surveyed key line. Wire is tightly stretched between two people at right angles to the key line and points marked every 20 metres along the row. See Figure 3. Rows up and down the slope are usually marked at right angles to the contour or parallel to the longest row.

more info



Names of citrus nurseries  
Section 6 page 5



**Figure 3.** Marking out parallel rows across a slope

### Deep rip along the rows

Where the land has been previously cultivated or grazed, deep rip to a depth of at least 60 cm along the rows. Ripping will also assist with the drainage of wet areas. If ripping downhill, lift the toolbar every 30 to 40 metres to avoid subsequent water scouring down the rip lines.

### Build contour drains/v-drains to control runoff

#### Main diversion drain above orchard

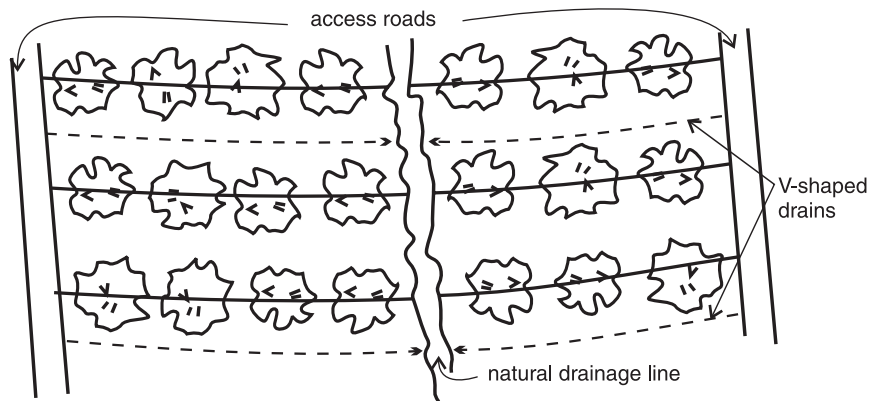
On sloping land, construct a major contour diversion drain above the orchard to divert water into a stable waterway or dam. The drain should be at a gradient of 1 to 5% and large enough to handle the water from the catchment above. Keep the steeper sections of the drain furthest from the waterway or dam unless you have very stable clay soils. Establish a creeping grass such as carpet grass, couch or African star grass in the drain channel to prevent scouring.

#### Contour drains and/or v-drains within orchard

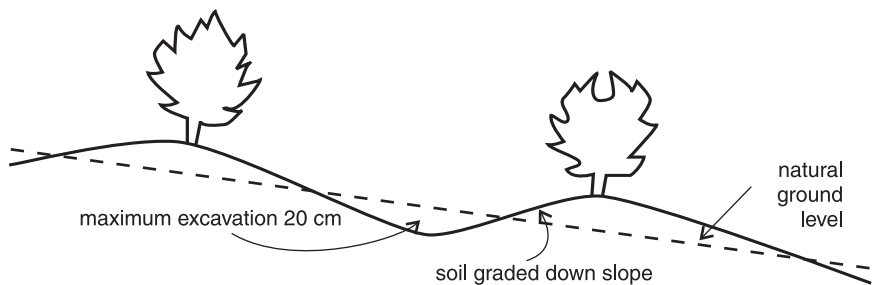
Within the orchard, there are two options to control waterflow and provide drainage. The first is to build major contour drains at least every 50 metres or so down the slope. These are built to similar specifications to the main diversion drain above.

The other option is to build shallow wide v-drains in the centre of the interrow area. V-drains have a maximum excavation of 20 cm and are usually built by a grader or tractor mounted blade.

For rows across the slope, v-drains are constructed every second or third row (Figure 4). Soil from the drain is moved onto the proposed downhill tree line (Figure 5).

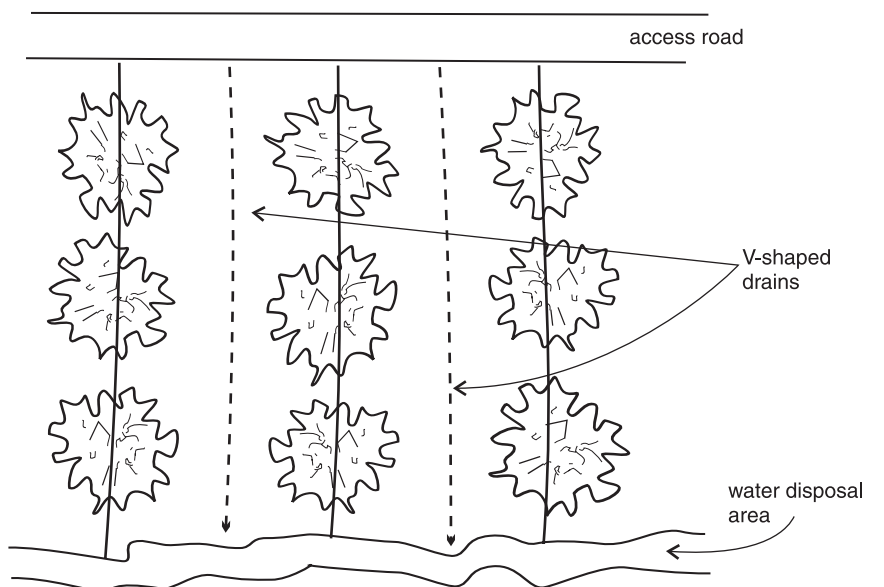


**Figure 4.** Across slope rows (plan view)

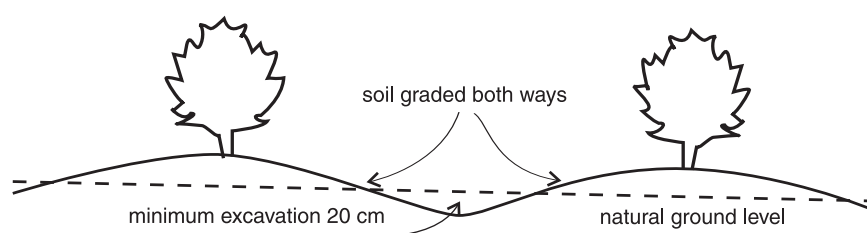


**Figure 5.** Across slope rows (cross-section view)

For rows up and down the slope, v-drains are constructed in every interrow area to control side slope runoff and to prevent water scouring down the tree rows (Figure 6). Soil from the drain is moved both ways on to the proposed tree lines (Figure 7).



**Figure 6.** Down slope rows (plan view)



**Figure 7.** Down slope rows (cross-section view)

Immediately after building v-drains, grass all disturbed areas to minimise erosion. Carpet grass and couch are commonly used but consider a taller growing grass such as Rhodes grass as this can later be a valuable source of grass mulch for under the trees.

### **Plant windbreak trees**

Where it is necessary to plant windbreak trees to supplement natural timber, plant trees at least 10 metres from the citrus tree rows to allow machinery access and to reduce competition for water and nutrients. Seek advice from forestry extension officers from the Department of Natural Resources.

When planting windbreak trees, first deep rip rows to a depth of at least 60 cm prior to planting. If ripping downhill, lift the toolbar every 30 metres to prevent water scouring down the rip lines. Plant the trees 4 metres apart. Mulch well with coarse straw. Install a separate irrigation line to keep the trees well watered. Regular applications of small quantities of a mixed tree fertiliser will promote rapid growth. Maintain a weed free area around the trees.

### **Do a soil analysis and apply required fertilisers**

Purchase a soil sampling kit from your local farm supply store. Follow the sampling instructions and send the sample away for analysis. Results should be back in about two weeks and will be interpreted by a representative of the laboratory analysing your sample. As a guide, the optimum soil nutrient levels to aim for are shown in Table 5 on page 23.

Samples should be analysed at least six months prior to planting. Discuss your results with your local farm supply agent and work out what fertilisers are required. Apply these fertilisers over the orchard site.

### **Cultivate strips along the tree rows**

Cultivate two metre wide strips along the tree rows. As well as incorporating the fertiliser, cultivation along the tree rows aids tree establishment and reduces initial weed competition. It is very important that fertilisers of low solubility such as lime, dolomite, gypsum, superphosphate, copper and zinc are well incorporated before planting.

Tined implements or a Turborota are preferred for cultivation. Don't overuse a rotary hoe as it can lead to soil compaction and soil structural problems as well as causing later settling of the tree row below ground level. This settling may cause subsequent soil erosion from water movement along the row.

### **Grow a green manure crop in the strips**

Where possible, grow a green manure crop in the cultivated strips. Use hybrid forage sorghum for spring or summer plantings, and oats in autumn or winter. A side dressing of urea or nitram two weeks after crop emergence will promote good growth. Slash when the green manure crop reaches one and a half metres in height and disc into the soil.

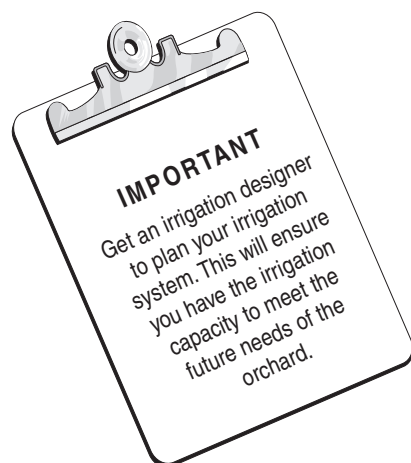
### **Mark out the tree plant sites**

Mark out the tree plant sites with a peg. In small orchards where organic materials are available, apply to each tree plant site either 10 litres of poultry manure, or two litres of pelleted poultry manure, or 20 litres of filterpress (mill mud), or 40 litres of an organic manure such as cow manure. Spread over a two square metre area at each site at least three months prior to planting and immediately incorporate into the soil. Spread a coarse mulch such as sorghum stubble over each site to a depth of 15 cm.

### **Install the irrigation system**

Install an irrigation system on the basis of an irrigation design plan prepared by a qualified irrigation designer. There are two options:

- Undertree minisprinklers with a microspray feature. The microspray feature is used for the first two years to limit water throw. Use sprinklers with an output of 80 to 250 litres per hour. Remember in the design of the irrigation system to allow capacity for the extra sprinklers to water your windbreak trees.
- T-tape trickle systems. For young trees, use one row of tape. When trees reach an age of about three to four years, a second row of tape is installed on the other side of the tree row. Trickle systems need to be very well designed to operate effectively and must be properly maintained to prevent blockages. High level filtration with sand filters is essential.



### **Plant the trees**

When you receive your trees, make sure they have good leaf colour, are free from pests and diseases, and have been hardened to full sunlight. Don't accept trees that are stunted, root bound or yellow.

## When to plant

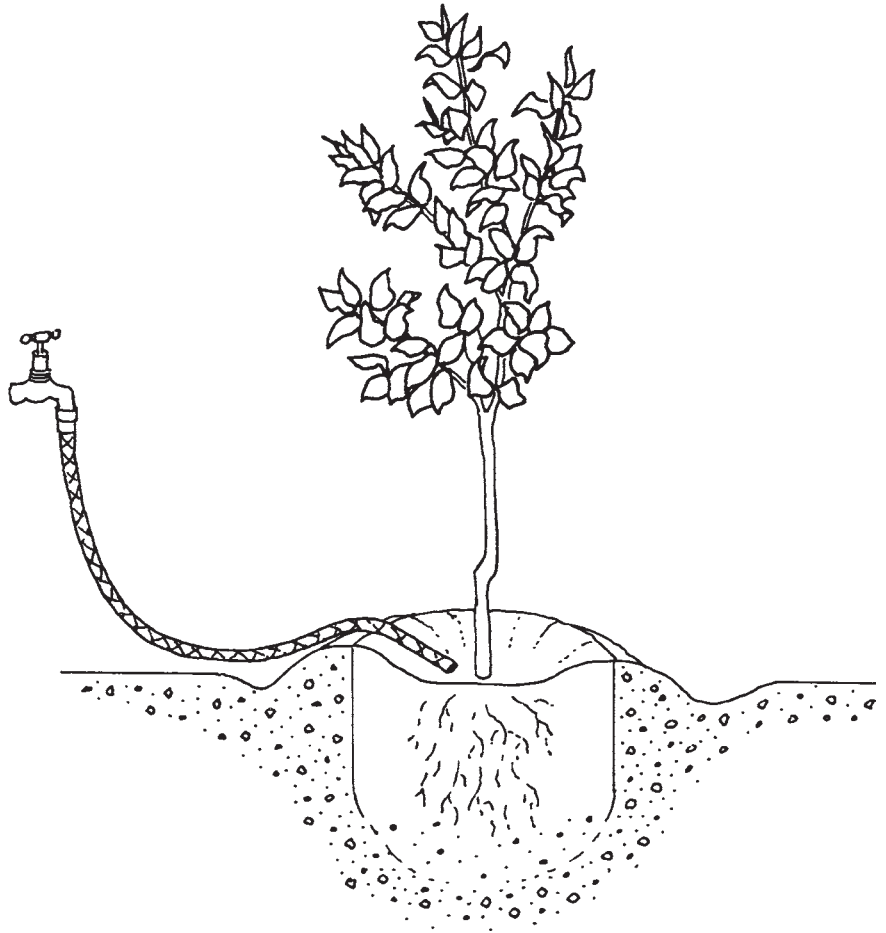
Citrus are best planted either in autumn or late winter after the risk of frost has passed. Autumn planted trees will need protection from frost. Follow the recommendations here and under *Managing young trees*. If trees are not sun hardened, gradually move them into stronger light over a two week period. Until planting, keep trees away from soil by placing on concrete or plastic sheeting.

## Planting procedure

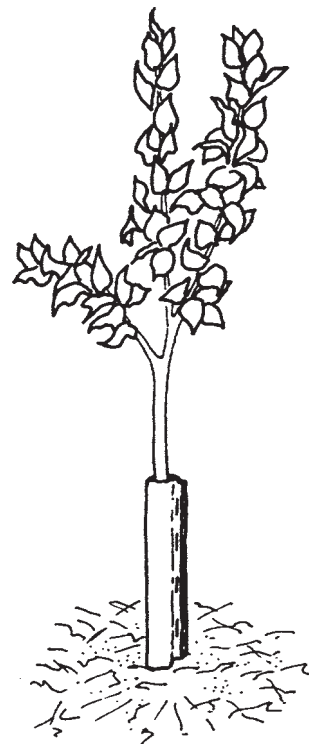
One to two days before planting, water to thoroughly wet tree sites to a depth of 30 cm. Do not plant trees during the hottest part of the day. Here are the steps for planting:

1. Dig a hole slightly deeper and wider than the bag. Do not use posthole diggers or augers. Do not place fertilisers or organic materials into the hole.
2. Remove tree from bag. Examine the root ball and straighten or trim any large roots sticking out at the bottom. Gently tease out the roots at the bottom of the root ball and shake away a little of the potting mix from the fibrous roots at the top of the root ball.
3. Place tree in hole so that the bud union is as high as possible without having any roots exposed.
4. Backfill the hole with soil and firm it down. Do not use your feet. In smaller orchards and those with standard planting densities, form a low wall of soil around each tree to hold water where this is practicable (Figure 8). Water thoroughly to soak the root ball and surrounding soil. This helps to bring the soil into close contact with the root ball.
5. Where mulch is available, apply a coarse mulch such as sorghum stubble, straw, cotton gin waste or similar to a depth of 15 cm. Keep the mulch 10 cm away from the trunk. Figure 8 shows a correctly planted tree.
6. Loosely wrap the trunks with either polythene tree protector sleeves or one thickness of sisalation as shown in Figure 9. This reduces suckering and protects the bark from damage by animals and herbicides.
7. Water the trees twice a week for the next four weeks.





**Figure 8.** A correctly planted tree. Note the low wall around each tree to retain water



**Figure 9.** Protection of young trees against frost and other damage by wrapping the trunks in a sleeve of protection material





## Managing young trees

*During the first three years, the aim is to grow a strong, healthy canopy of branches and leaves that will be able to produce well in future years. There are six important operations.*

Fertilise .....	16
Water .....	17
Prune .....	19
Control weeds and apply mulch .....	19
Control pests and diseases .....	20
Prevent frost damage .....	21

### Fertilise

Don't start fertilising until the young trees have started to put on new growth. Then fertilise little and often, at least once every month from September to May. For larger orchards, application every second month is more practicable. The recommended annual application per tree per year of age is 100 g of nitrogen, 10 g of phosphorus and 50 g of potassium. This is equivalent to about 400 g of a 13:2:13 mixed fertiliser plus 100 g urea. Multiply this by the age of the tree in years to calculate the annual requirement per tree. For example, a three year old tree would require 1200 g of a 13:2:13 mixed fertiliser plus 300 g urea. If applied once a month from September to May, this equates to nine applications of approximately 140 g of the mixed fertiliser plus 40 g urea.

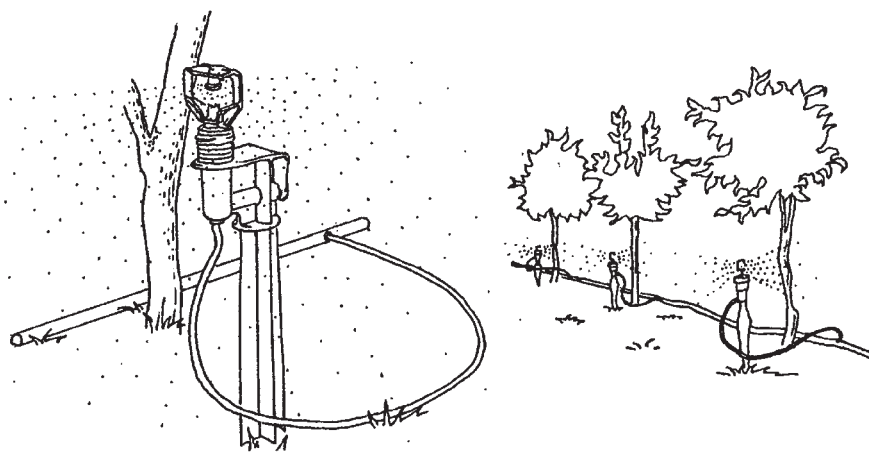
Spread the fertiliser in a broad ring around the tree extending 50 cm beyond the canopy. Keep the fertiliser 10 cm away from the trunk.

Fertiliser may also be applied through the irrigation system (fertigation). Some commercial preparations are specially made for fertigation. Inject the fertilisers when you have almost finished irrigating to avoid leaching of nutrients. Irrigate for another 10 minutes after fertigating to flush any remaining fertiliser out of the irrigation lines.

Newly planted trees benefit from an annual copper spray for the first three years after planting. Use copper oxychloride (400 g/100 L water) or copper hydroxide (200 g/100 L water). Apply in spring.

## Water

For the first few months after planting, apply about 20 litres of water per tree two or three times per week. If using minisprinklers, use the microspray mode to limit the spread of water. Towards the end of the second year, convert the sprinkler back to the minisprinkler mode to increase the wetted area and encourage rapid root spread. The set up for a minisprinkler watering system is shown in Figure 10.



**Figure 10.** Minisprinkler watering system for young trees

a key issue



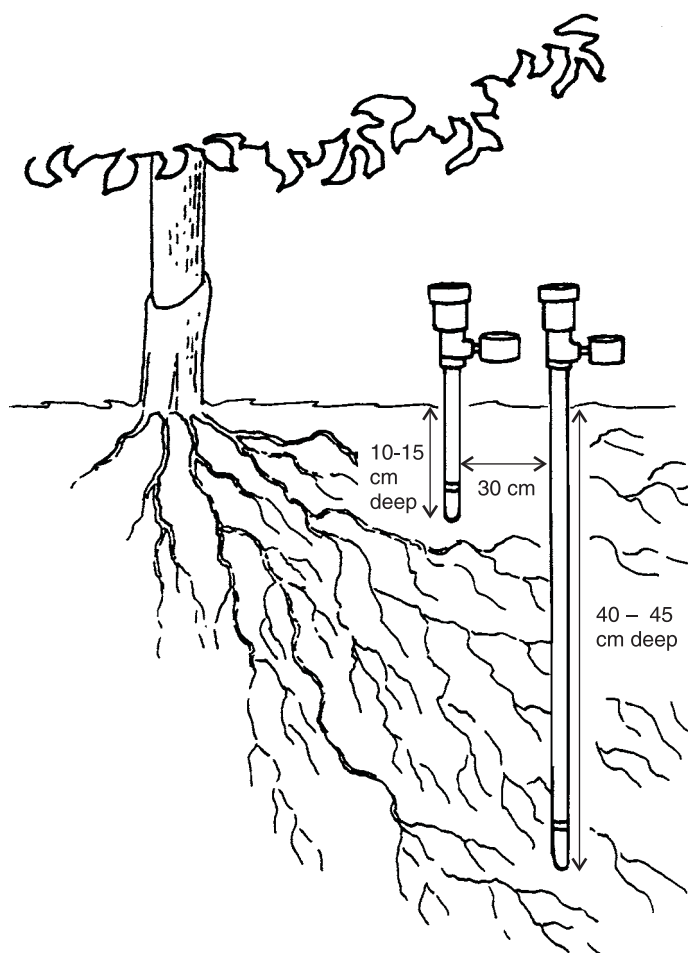
Irrigation scheduling  
Section 4 page 41

Once the trees are established, it is difficult to know how much water to apply. Too much can lead to waterlogging and root rot and too little can stress the trees and stunt growth. Common sense is required but irrigation management can be improved greatly by basing watering rates and frequency on a soil moisture monitoring system. There are three main options, each with its pros and cons. The choice will depend on the degree of accuracy required and the available budget. The three main choices are:

- **tensiometers.** These are devices which are positioned in the tree row about one month after planting. They have the advantage that they are relatively inexpensive and can be installed and read by growers themselves. Disadvantages are their inaccuracy particularly in dry soil conditions and their inability to effectively monitor the top 10 cm of soil. The value of tensiometers is also only as good as the grower's ability to regularly make the readings and to maintain the devices in good working order.

Position two tensiometers (one 30 cm long and the other 60 to 90 cm long) in each irrigated block to the depths shown in Figure 11. Place on the north-eastern side of a healthy tree, inside the dripline and where they will receive water from sprinklers. Read tensiometers in the morning before 8 am. Start watering when the shallow tensiometer reads 20 cb (on sandy soils) and 30 to 40 cb (on loam and clay loam soils). Stop watering when the reading on the deep tensiometer falls to 10 cb. Reposition tensiometers every second year in winter to the new dripline position. Once a week, remove

any accumulated air and check that gauges are working using a vacuum pump. Refill tensiometers with clean water.



**Figure 11.** *Installing tensiometers under trees*

- **neutron probe.** This is a very sophisticated device generally used by consultants to monitor and provide recommendations for watering. The consultant will set up a number of access holes in the orchard and bring the probe to these sites during the season. The neutron probe is more accurate than tensiometers but its value is dependent on how regularly the consultant visits and makes readings. It also has difficulty in accurately monitoring the top 10 cm of soil.
- **Enviroscan probe.** This is a continuous moisture monitoring device based on capacitance sensors. The sensors are mounted on probes installed in PVC tubes which are put in after the trees have been established. The sensors are connected by a cable to a data logger with measurements being made automatically at regular intervals. The data from the logger is downloaded to a computer every few days to provide recommendations for watering. Although the units are relatively expensive, they are more accurate than tensiometers and neutron probes and they allow continuous and regular monitoring of soil moisture. They also accurately

more info



Irrigation consultants  
Section 6 page 6

monitor the top 10 cm of soil. We recommend that you engage a consultant to help develop and fine-tune this system.

It is important to point out that these systems may not actually reduce water use but watering will certainly more accurately suit the seasonal needs of the trees.

If these systems are not being used, Table 4 provides a rough guide to minisprinkler watering rates for trees from three months to three years of age. The table makes no allowance for rainfall or very dry weather. Only the moisture monitoring devices can make this allowance.

**Table 4.** *Irrigating young trees*

Tree age	Sept-Feb	Mar-May	June-Aug
4 to 20 months (microspray mode)	20 - 40 L/tree	20 - 40 L/tree	20 - 30 L/tree
20 months to 3 years (minisprinkler mode)	420 - 590 L/tree	420 - 590 L/tree	420 - 590 L/tree
Frequency	every 5 - 7 days	every 10 - 15 days	every 15 - 20 days

### Prune the trees

Minimise pruning of young trees as removal of foliage delays the development of fruit bearing capacity. The desired structure of young trees is an arrangement of three or four well-spaced main limbs 45 to 60 cm from the ground. Most young trees develop naturally into this shape and therefore require no pruning. The only pruning that should be done during the first three years is the removal of badly crossed branches and unwanted shoots from the lower trunk. Also shorten or remove vigorous shoots from the centre of the tree. In vigorous varieties such as lemons and Glen, Hickson, Imperial and Murcott mandarins, shorten long whippy shoots in winter to a third of their length.



### Control weeds and apply mulch

Newly planted trees find it difficult to compete with weeds for water and nutrients. Therefore weed control in the immediate vicinity of the young trees is vital. Achieve this by either mulching or spraying under and around the trees. The mulched or sprayed area should extend to just beyond the dripline of the trees, making it roughly two metres wide. Maintain a grassed area in the interrow between the mulched or sprayed strips.

Mulching is only viable on small orchards. Where it is used, keep the mulch well away from the trunk to avoid collar rot. Reduce mulch costs by either growing mulch materials between the rows for later slashing or letting the grass sward grow high enough to ensure there is a sufficient volume available. Renew the mulch before it breaks down.

Mulch increases soil organic matter, improves soil structure and reduces root temperature fluctuations. It also increases water retention and may reduce irrigation frequency and amount.

Larger orchards may find side-delivery mowers useful in throwing the mown grass from the inter-row sward in under the trees. Besides being a potential source of mulch, the grass sward between the rows also eliminates dust and provides pollen as a food source for predatory mites. These are important factors in the success of integrated pest management.

Where mulching is not practical, use herbicides. On smaller farms, these can be applied by hand operated equipment but on larger farms, use either a boom spray under the trees or a low volume CDA sprayer. We recommend use of the knockdown herbicides such as paraquat or paraquat/diquat mixtures with the odd application of glyphosate to clean up any difficult-to-control weeds. However, it is preferable not to use glyphosate in orchards under three years old because of the risk of herbicide drift onto the developing trunk and leaves of young trees. The trunk protection sleeves shown earlier help in reducing this risk. Also minimise drift by using a shielded, low-pressure fan or flood nozzle.

Table 10 on page 30 contains details of registered herbicides. Residual herbicides are also available but should be used with care.



## Control pests and diseases

---

### Pests

The most important pests of young citrus trees are leafminer, mites, scales and aphids. Follow the control measures in the *Pest and Disease Management Handy Guide* and the *Problem Solver Handy Guide*.

### Diseases

The most important diseases of young citrus trees are the leaf diseases (brown spot, scab and melanose), anthracnose, and Phytophthora root and collar rot. For brown spot (Murcott, Emperor and Nova only), scab, melanose and anthracnose, follow the recommendations in the *Pest and Disease Management Handy Guide* and the *Problem Solver Handy Guide*. It is advisable to give all young trees at least one copper spray in spring. Apply this spray to the spring flush.

Where Phytophthora root and collar rot is a problem, for example in replant land, marginal soils or where watering has been poorly managed, spray trees up to four times a year with a phosphorous acid product selected from the *Problem Solver Handy Guide*. Follow label directions. Do not use higher concentrations as leaf fall may result, particularly in trees under stress.

## Prevent frost damage

---

Young trees can be killed by frosts. The protective sleeves recommended earlier will give adequate protection in mild frost situations. However where severe frosts are expected, extra precautions need to be taken. These are:

- In small orchards, wrap a thick bundle of dry straw around the trunk and fasten with twine. The straw should extend from the ground up past the main branching area into the foliage. Some foliage damage is acceptable as long as the main trunk and scaffold branching area is not damaged.
- A copper spray just before winter will limit damage by reducing the number of nucleation bacteria around which the ice crystals form.
- The bare herbicide strip along the young tree line, provided it is moist and firm, gives added protection against frost.
- The grassed interrow area increases the frost hazard in newly planted orchards if the grass is left to grow long and then dry off during winter. Mow the grass to keep it short.
- Dry mulches can also increase the severity of frost damage. Keep the mulch wet but be absolutely sure not to overwater the root zone in winter.
- Don't start removing frost damaged wood until about October when the full extent of damage should be visible.
- Frost damaged trees lose leaves, branches and roots and will need less fertiliser and irrigation than undamaged trees of the same age.



## Managing bearing trees

Once trees begin to bear, the focus of management changes. Prior to bearing, the aim is to build a strong healthy framework. Between the fourth and eighth year, the object is to increase the fruit bearing surface rapidly while at the same time producing quality fruit. By the eighth year when trees should have filled in most of the area available, the sole objective is the maximum production of quality fruit. Thus many of the orchard practices previously aimed solely at leaf and tree growth change.

High performing trees follow a definite crop cycle of leaf growth, flowering and fruit development. The aim of management is to manipulate fertilising, watering and other operations to maintain the trees in this desired cycle. Here are the important management operations:



Calendar of things to do is in Crop Production Handy Guide

Fertilise .....	22
Water .....	25
Prune and control tree size .....	26
Special treatments .....	28
Control weeds .....	29
Control pests and diseases .....	30
Manage pollination .....	34
Maintain windbreaks .....	34
Inducing an 'out-of-season' lime crop .....	34

### Fertilise

#### Timing of fertiliser application

Citrus trees produce flowers on wood which is at least 12 months old. The spring leaf flush provides the wood for flowering, fruit set and development of the following crop. Consequently, management of fertiliser, in particular nitrogen, is aimed at producing maximum growth of the spring flush. To achieve this, apply all of the annual nitrogen fertiliser in June and July. Nitrogen at other times will encourage unwanted growth flushes. The exception to this is Murcott which benefits from periodic light applications of nitrogen from June to March.

Timing of application of phosphorus and potassium is not as critical although potassium application is preferred during the period August

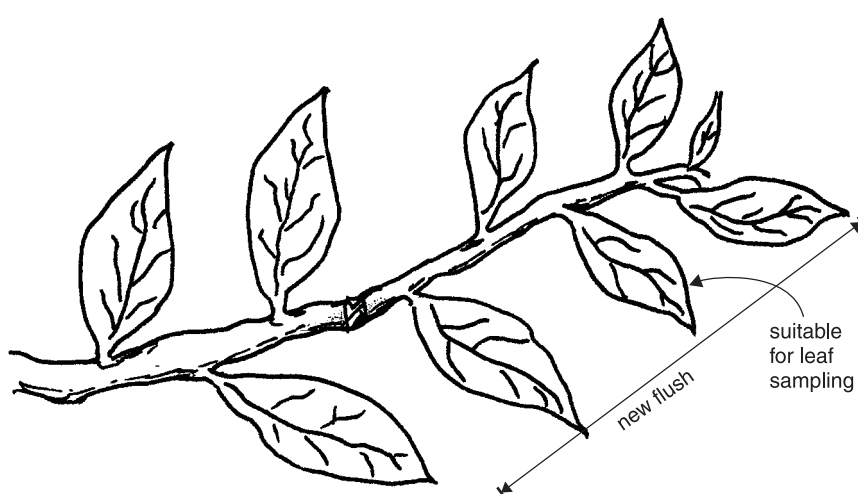


Nutrition management  
Section 4 page 35

to October. Otherwise, apply them with the nitrogen for convenience. For Murcott, apply potassium with nitrogen as mentioned above.

### Soil and leaf analysis

Base fertiliser application on leaf and soil analysis results. Take the first samples in year four and each year from then onwards. Sample the middle leaf from a non fruiting terminal of the previous spring flush (Figure 12). Sample in February/March when the flush is about five to seven months old. The right terminals to sample can be difficult to identify correctly. If you take leaves from the wrong ones, analysis results will be misleading. If you are not experienced, seek advice from a local citrus consultant.



**Figure 12.** The correct leaf to sample for leaf analysis

Leaf and soil sampling kits with full instructions are available from most farm supply outlets. The laboratory handling your sample will interpret the results and make recommendations. The aim of fertilising is to maintain leaf and soil nutrient levels within specified optimum ranges. The optimum ranges for nutrients are listed in Tables 5 and 6.

**Table 5.** Optimum soil nutrient levels for bearing trees

Element	Optimum soil levels
pH (1:5 water)	5.5 – 6.5
Organic carbon	more than 3.0%C
Nitrogen	not applicable — use leaf analysis
Sulphate sulphur (Phos-extr)	more than 15 mg/kg S
Phosphorus (bicarb-Colwell)	more than 80 mg/kg P
Potassium (Amm. acetate)	more than 0.5 meq/100 g K
Calcium (Amm. acetate)	more than 5 meq/100 g Ca
Magnesium (Amm. acetate)	1.6 meq/100 g Mg
Sodium (Amm. acetate)	less than 1 meq/100 g Na
Chloride	less than 250 mg/kg Cl
Conductivity (sat.extract equiv)	less than 2 dS/m
Copper (DPTA)	0.3 – 10 mg/kg Cu
Zinc (DPTA)	2 – 10 mg/kg Zn
Manganese (DPTA)	4 – 45 mg/kg Mn
Iron (DPTA)	more than 2 mg/kg Fe
Boron (Calcium chloride)	more than 1 mg/kg B



**Table 6.** Optimum leaf nutrient levels

Element	Optimum leaf levels	
Nitrogen	2.40 – 2.60% N	
Sulphur	0.20 – 0.40% S	
Phosphorus	0.12 – 0.16% P	
Potassium	0.70 – 0.90% K	(Navel, Ellendale, grapefruit)
	0.90 – 1.20% K	(Joppa, Valencia, mandarins other than those below)
	1.20 – 1.70% K	(Imperial, Murcott, Emperor, Glen, lemons)
Calcium	3.00 – 6.00% Ca	
Magnesium	0.25 – 0.60% Mg	
Sodium	less than 0.16% Na	
Chloride	less than 0.30% Cl	
Copper	5.0 – 10.0 mg/kg Cu	
Zinc	25 – 100 mg/kg Zn	
Manganese	25 – 100 mg/kg Mn	
Iron	60 – 120 mg/kg Fe	
Boron	30 – 100 mg/kg B	
Molybdenum	0.10 – 3.00 mg/kg Mo	

In the absence of leaf and soil analysis results, apply 100 g of nitrogen, 10 g of phosphorus and 50 g of potassium for each year of the tree's age up to a maximum of eight years. This recommendation is based on a density of 250 trees per hectare. Do not exceed a rate of 200 kg of nitrogen per hectare for densities up to 500 trees per hectare. Rates for higher density plantings have not yet been developed.

Table 7 converts these requirements into rates of fertilisers to apply. Two options are detailed. The first is based on single nutrient fertilisers (straight fertilisers) and the second on a combination of single nutrient plus mixed (blend) fertilisers.

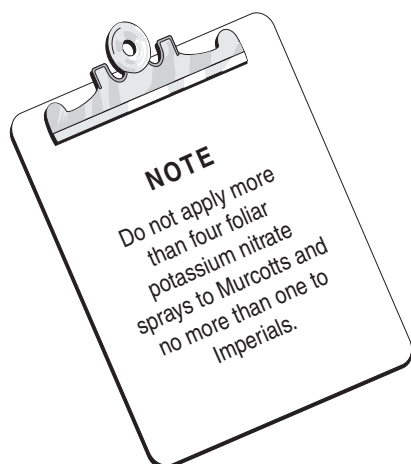
Remember these are a guide only and the actual rates used should be based on leaf and soil analysis, crop yields, fruit quality, soil type and so on.

**Table 7.** Fertilising options

Tree age	Quantity of element required (g)			Option 1			Option 2	
				Quantity of fertiliser required (g)			Quantity of fertiliser required (g)	
	N	P	K	Urea	Super	Sulphate of potash	CK77S	Urea
4	400	40	200	870	400	490	1528	434
5	500	50	250	1085	500	610	1923	543
6	600	60	300	1302	600	731	2307	652
7	700	70	350	1519	700	853	2692	760
8	800	80	400	1736	800	975	3076	869

## Placement

Mature tree roots extend into the middle of the row so the whole of the orchard should receive some fertiliser. Set up the fertiliser spreader to place most of the fertiliser under the tree canopy.



### Foliar applications

Because of heavy crop loads, Murcott mandarins respond well to foliar applications of potassium nitrate in addition to the above recommendations. Up to a maximum of four applications may be applied between December and March. Use a rate of 20 g per litre of water. Be guided by the health of the tree and the crop load. This recommendation may seem at odds with the previously mentioned practice of limiting nitrogen to June/July only. However, it is justified in this case because of the excessive drain on Murcott trees from the heavy fruit load.

In a similar vein, Imperial mandarins may also benefit, but make only one application after harvest and before spring flowering and fruit set.

### Soil pH

Maintain soil pH between 6 and 6.5. Apply lime or dolomite to keep pH in the desired range. Base application rates on soil analysis results.

### Minor nutrients

Where leaf and soil analysis is used, apply rates recommended by the testing laboratory. Where leaf analysis is not used, apply rates as detailed in Table 8. Apply these nutrients as foliar sprays to the expanding spring flush. Remember that without leaf analysis results to guide you, rates in excess of requirements may be applied.

Apply zinc annually, magnesium and manganese as required, and boron every second or third year. Where trace elements are being applied as foliar sprays, use high volume sprays only.



Nutrition management  
Section 4 page 35

**Table 8.** Trace element application rates

Nutrient	Product	Product per 100L
Zinc	Zinc sulphate heptahydrate	100 g
Magnesium	Magnesium sulphate plus calcium nitrate	1 kg + 800 g
	or magnesium nitrate	1.5 kg
Boron	Solubor	150 g
Manganese	Manganese sulphate	100 g

### Water

Continue using the soil moisture monitoring devices (tensiometers, neutron probe or Enviroscan) recommended earlier for young trees as a guide to watering rates and timing.

If using tensiometers, use similar positions as recommended there but place them deeper in the soil. Place the first tensiometer at a depth of about 25cm and the second at a depth of about 60 cm.

Remember to carry out the readings before 8 a.m. each morning. Start watering when the shallow tensiometer reads 10 centibars on sandy soils or 35 centibars on heavy soils. Stop irrigating when the deep



Irrigation management  
Section 4 page 41

tensiometer reads 0 – 10 centibars. It is essential to maintain tensiometers in correct working order.

If moisture monitoring systems are not being used, Table 9, based on evaporation figures for the Central Burnett, can be used as a guide to watering. Use minisprinklers with a minimum output of 96 L per hour. Use a maximum of a 10 hour irrigation. For trees younger than eight years of age, decrease the duration of the irrigation by about one hour for every year of age. For example, a five year old tree needs about seven hours irrigation. Remember that the figures in the table make no allowance for rainfall or very dry weather. Only the moisture monitoring devices can make this allowance.

**Table 9.** Irrigating bearing trees from 8 years onwards (based on 250 trees/ha)

Time of year	Growth stage	L/tree/ application	Number of applications
June – July	Dormant & 1st fertiliser application	960	1 – 2
August	Preflowering & 2nd fertiliser application	960	2
Sept – Nov	Spring flush	960	9 – 10
Dec – Mar	Fruit	960	18 – 19
April – May	Preharvest	960	4

## Prune and control tree size

### Pruning

As trees grow, they produce a dense canopy of leaves. If this is allowed to continue unchecked, fruit production will be confined to the outer perimeter of the canopy because of insufficient light reaching the centre of the tree. The dense canopy and network of branches also starts to reduce the efficiency of pest and disease management and harvesting. Pruning then becomes necessary. Pruning also helps in the management of fruit thinning as a correctly pruned tree does not set as many fruit.

Start pruning when trees are about 2½ metres tall (roughly about four to six years of age). From then on, prune trees preferably each year but at least every second year. The best time is after harvest and before flowering but trees can be pruned at any time of the year. Use manual or pneumatic secateurs, pruning saws or small chain saws.

There are three main operations in pruning:

- Remove any dead wood from the tree.
- Skirt trees by removing all branches and shoots below a height of 30 cm from the ground. This also improves fertilising, irrigation, weed control and other orchard operations.
- Thin out selected branches within the canopy particularly towards the centre of the tree to allow more light to penetrate.



More detail on pruning  
Section 4 page 53

Pruning is particularly necessary for vigorous heavy cropping varieties such as lemons and Glen, Hickson, Imperial and Murcott mandarins.

### Hedging

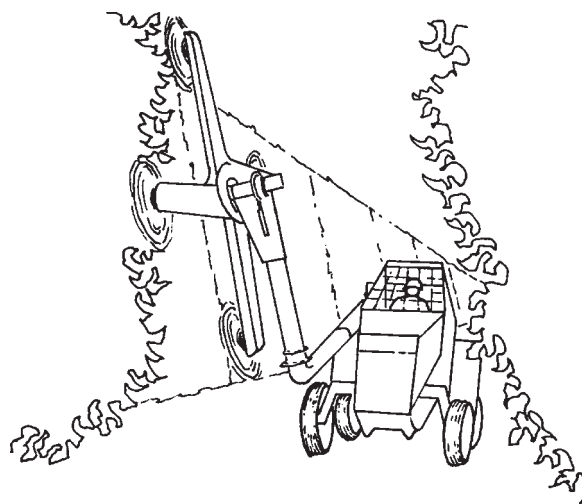
In mature orchards, hedging or trimming back the sides of trees is necessary to maintain access for spraying and harvesting. Trim only one side of a row each year.

At the same time, cut the top of the trees (called topping) to a height of 4 to 4.6 metres. Topping needs to be done almost every year to allow efficient pest management, easier harvesting and light penetration to the next row. Hedging and topping machinery is expensive and most orchardists hire a contractor. Place all prunings in the interrow for mulching with heavy mowers. An illustration of hedging is shown in Figure 13 and desired tree shapes in Figure 14.

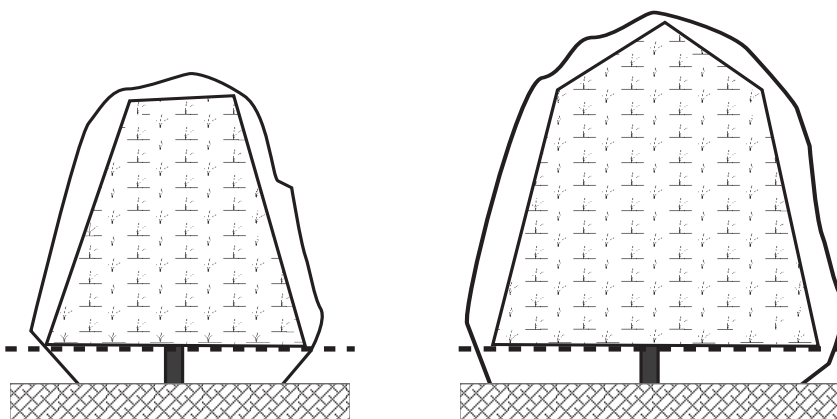
more info



Hedging contractors  
Section 6 page 6



**Figure 13.** A modern hedging and topping machine



**Figure 14.** Desired tree shapes after hedging and topping. Left: younger trees up to about eight years. Right: mature trees. The angle of hedging is about 15 degrees.

## Tree removal

Tree removal is not usually needed if standard planting distances are used. In closely planted orchards, it may become necessary to remove every second tree as branches grow together and yields decline. Timing of removal will vary with variety, initial tree spacing, climate and soil type.

## Special treatments

### Thinning

The mandarin varieties Imperial, Murcott, Hickson, Glen and Fremont set far too many fruit. Some must be removed to maintain good fruit size and to avoid alternate bearing and tree death. The removal of excess fruit is called 'thinning'. Valencia oranges for export also need to be thinned to maintain fruit size.

Fruit may be thinned chemically or by hand. Hand thinning is more accurate but is very labour intensive. Remove small fruit, marked or damaged fruit and fruit hanging close to the ground. Thin clusters to one or two fruit. Leave the terminal fruit in Imperials and Glens. As chemical thinning rates have not been established for Fremont, thin this variety by hand only.

Chemical thinning uses the chemical ethephon (Ethrel, Bounty, Promote). Water trees a day or two before application to avoid any stress. Use a rate of 50 mL/100 L water (60 mL/100L for Murcott) and apply a minimum of 3000 L of water per hectare, avoiding runoff. Higher rates will cause excessive leaf and fruit fall. Complete coverage of fruitlets is essential. Make sure the volume of water is sufficient to wet the small fruitlets.

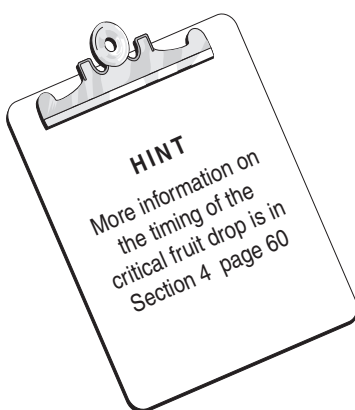
Timing of the thinning spray is critical. Apply it during the last natural fruit drop period in November. Monitor fruit drop to determine this period. Sweep clean an area under several trees and observe fruit drop every two days from early October (north Queensland) and mid October (south Queensland). Sweep the patch clean after every observation and record counts. When 20% of the fallen fruit are 8 to 15 mm in diameter, apply the spray. Use a ruler or vernier calipers to accurately measure fruit diameter.

### Control of rind ageing

In Ellendale, Hickson and Imperial mandarins, the fruit rind of mature fruit may become soft and loose and separate from the fruit segments. This condition is called puffiness and often develops before fruit reaches its market destination. To prevent this, apply a spray of gibberellic acid (Progibb GA, Grocel GA) at a rate of 10 mL /100 L water. Spray trees to wetness, avoiding runoff. Follow label directions. Complete coverage is essential. Apply when fruit is almost full colour.



Fruit thinning  
Section 4 page 58



If it is applied too early, fruit will retain any green colour and will be difficult to degreen.

If premature fruit drop is a problem, add Cit-tite to the gibberellic acid. Rates vary from 120 to 200 mL/1000 L water. Check the label for more information (updated January 2000).

As Imperial mandarins mature very rapidly, the gibberellic acid spray also helps to spread the harvest and avoid fruit collapsing on the trees, particularly during late season rain. It also reduces the potential for rind damage during packing. A common practice is to pick the first mature fruits and then apply the spray to the remainder, particularly where rain is imminent. Don't let fruit treated with gibberellic acid hang too late or next season's crop will be reduced.

### Reducing creasing

Creasing affects ripe fruit while still on the tree. Navel and Valencia oranges and Ellendale and Murcott mandarins are most affected. Creasing shows as irregular, sunken, narrow furrows in the rind. Where there has been a history of creasing, a gibberellic acid spray will help to reduce the problem. Apply when fruit are 50 mm in diameter. Use a rate of 20 mL/100 L water. Good coverage of the fruit is essential.

### Control weeds

Maintain the interrow grass sward and continue either mulching or spraying for weeds as outlined under *Managing young trees*.

If using herbicides, maintain the weed free strip down each side of the row and under the trees. The width of the strip varies according to the size of the tree. Apply herbicides with a correctly calibrated boom sprayer. This ensures evenness of application, reducing wastage and the potential for plant damage. Also minimise drift by using shielded, low-pressure fan or flood nozzles.

Continue to use the knockdown herbicides such as paraquat or paraquat/diquat mixtures with the odd application of glyphosate to clean up any difficult-to-control weeds. Residual herbicides are also available but should be used with care. Table 10 contains details of registered herbicides.



**Table 10.** List of registered herbicides

Chemical name	Trade names
glyphosate	Roundup, Glyphos, Glyphoz, Ranger, Sanos, Touch-down, Wipe-Out, Glyphosate, Pacer
diquat	Reglone
diuron	Karmex, Diuron, Diurex, Diugranz, Die-It, Di-On, Striker
bromacil	Hyvar X, Bromacil
paraquat	Gramoxone, Nuquat, Para-Di 200
paraquat plus diquat	Spray Seed, Tryquat
bromacil and diuron	Krovar
norflurazon	Solicam
fluometuron	Cottonex
haloxyfop	Verdict
dichlobenil	Casoran
pendimethalin	Stomp
oryzalin	Surflan (grapefruit only)
oryzalin plus simazine	Dow Elanco 500 (oranges and grapefruit only)
simazine	Gesatop, Simazine, Lupizine, Simatox, Simagranz, Simanex

## Control pests and diseases

The first thing to understand is that there are both insect pests and diseases likely to attack the crop and the approach to controlling each is quite different.

### Insect pests

The old approach to pest control was to apply routine calendar sprays. This approach had four main problems:

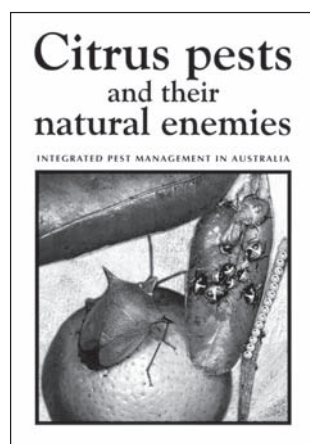
- It was a waste of money if the pests were absent.
- Even when pests were present, it disregarded the fact that plants can tolerate small numbers of pests without significantly affecting yield and quality. In these cases, the cost of spraying is much greater than the benefit gained by controlling the pest.
- It increased the risk of chemical burn to the fruit.
- It increased the amount of chemical residue in both the fruit and the environment.

The modern approach to insect pest control involves checking the crop regularly to determine when pests are present. Only when they are present and at damaging levels, are chemicals or other control measures applied. This process of checking the crop to determine the need for control measures is called monitoring.

The system works around pre-determined pest action levels—pest populations at which damage is considered worthy of attention. The action level can be thought of as the point at which the damage is roughly equivalent to the cost of control. Monitoring enables pest levels to be measured and compared with the action levels. Control measures are applied only when pest populations approach or reach



Insect pest  
management  
Section 4 page 49



Use this book for more  
detail on IPM

See Section 6 page 13

more info



Pest consultants  
Section 6 page 4

these action levels. Monitoring then continues to allow pest populations to be managed at or below these action levels. As well as the pests, the beneficial insects and mites which naturally attack the pests are also monitored. This is done because in some cases, they alone will be sufficient to keep the pest populations in check.

Monitoring is an integral part of a special strategy known as integrated pest management (IPM). IPM aims to reduce the reliance on chemicals by using a range of complementary pest management techniques such as biological control (beneficial parasites and predators of the pests) and cultural control (crop hygiene, crop rotation etc). Chemicals are only used when necessary and preference is given to chemicals which are compatible with beneficial insects and 'softer' on the environment. An IPM system which uses parasites and predators is now well established in citrus. In some situations, pests such as red scale, mealybug and mites can be well controlled without chemicals. Pests normally requiring some chemical control include Queensland fruit fly, some soft scales, aphids, leafminer, gall wasp and bugs. IPM works better in dry inland areas and requires a high level of management and/or pest consultant support.

Because monitoring requires some skill in identifying pests and recording population levels, the use of professional pest monitoring services is recommended. Where a full IPM program cannot be used, a broad program for monitoring and strategic chemical control of the main pests is contained in the *Pest and Disease Management Handy Guide*.

### **Diseases**

The approach to disease control is different to that for insect pests. As disease organisms are microscopic, they cannot be seen and therefore their arrival and buildup in the crop cannot be as easily monitored. In most cases, this requires routine preventative spraying to protect the crop from possible infection. The major diseases requiring spraying are black spot and melanose (which cause skin blemishes on fruit), anthracnose and brown spot (which affect both fruit and foliage), and Phytophthora root and collar rot (may also affect the fruit in cool wet periods). A broad program for disease control is contained in the *Pest and Disease Management Handy Guide*.

### **Pesticide application and safety**

Overall, experience has shown that the best machine for spraying citrus trees is a high pressure, hydraulic, oscillating boom sprayer (Figure 15). If it is to be the sole sprayer for the orchard, it will need to be operated in young trees with the top nozzles blocked off.

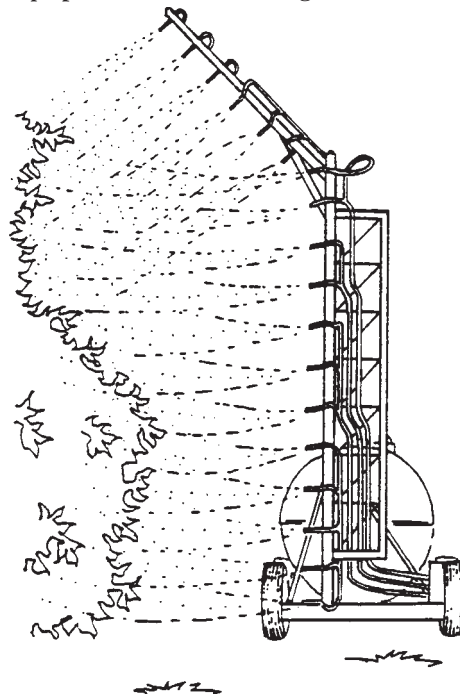
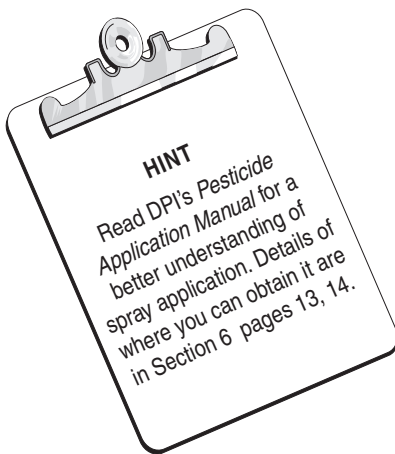
In larger orchards where two sprayers are necessary, a low profile air blast machine (Figure 16) can be suitable for younger trees up to a height of about 3 metres. However, it does not provide adequate coverage of leaves and fruit in the tops of larger trees. For this, an air blast machine with tower (Figure 17) is required but it must be set up



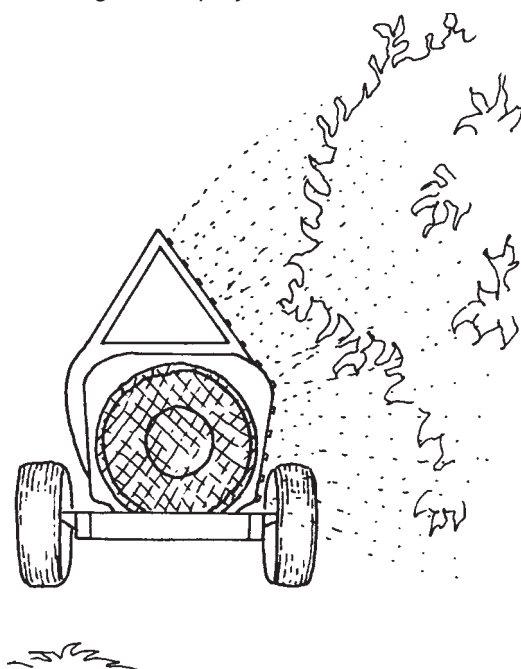
and operated under a particular set of conditions. For example, the sprayer needs to have a large capacity pump and fan and be operated at a slow speed to apply at least 8000 litres of spray per hectare. It is also only effective when trees are properly pruned to allow effective spray penetration.

A separate spray boom rig is required for applying herbicides.

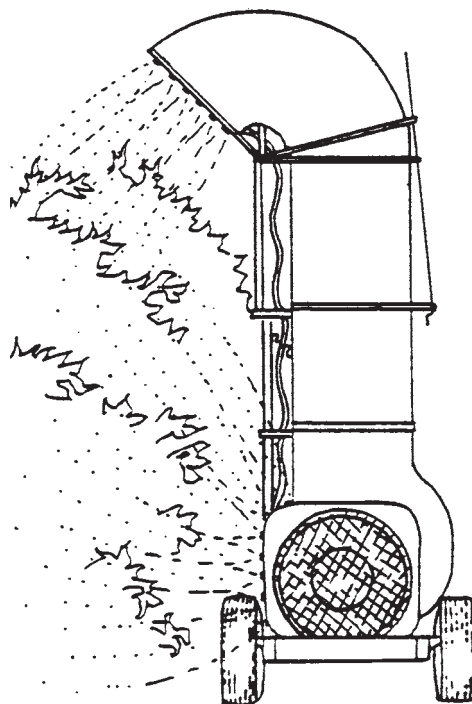
All citrus spray machinery must be regularly maintained and calibrated to ensure sufficient chemical is applied to each tree. Before using chemicals, read the label carefully. Observe all safety precautions and wear protective equipment and clothing.



**Figure 15.** An oscillating boom sprayer



**Figure 16.** A low profile air blast sprayer suitable for young trees up to 3 metres



*Figure 17. Air blast sprayer with tower*

### **Spray compatibilities**

It is often convenient to mix spray materials and apply them in the one operation. This saves time and may be done safely with many of the citrus sprays. However, knowledge of the compatibility of every spray used in citrus is incomplete and it is recommended that you follow the advice on the labels of the chemicals you are using.

### **Manage pollination**

---

Citrus appear to be well pollinated naturally without the need for the introduction of bee hives. Although clearing of native forests has reduced naturally-occurring bee populations, no real pollination problems are yet being observed. There is no trial data to show that bees are necessary for improved cropping but it would be reasonable to suggest that bees are a benefit. Current research on citrus pollination should soon clarify this. Some growers hire hives for the blossom season. Invite an apiarist to discuss your requirements and to arrange placement of hives. Remember that some orchard sprays can be harmful to bees.

### **Maintain windbreaks**

---

Deep rip at least every second year between the windbreak trees and the citrus trees to reduce competition for water and nutrients. Rip lines should be at least two metres from the canopy edge. If spreading foliage is reducing access to the trees, trim the sides of the windbreak trees.

### **Inducing an 'out-of-season' lime crop**

---

To take advantage of high seasonal prices for limes around Christmas time, some growers have experimented with the Italian Verdelli system to produce 'out-of-season' crops. Here are the main steps of the Verdelli system:

1. Stop applying fertiliser, particularly nitrogen, in November. This runs down nitrogen reserves in the trees.
2. Harvest the main natural crop in March/April.
3. Immediately after harvest, stress the trees by withholding all irrigation. This is done until about the end of May.
4. In early June, start to water thoroughly and apply about one-third of the normal yearly rate of nitrogen fertiliser. This should induce a flowering in late June.
5. Fruit growth will be slow during the remainder of the winter but fruit should mature six to eight weeks ahead of schedule. Ensure trees receive adequate water during the normally dry spring period otherwise excessive fruit drop can occur.

The system works best in sandy soils in dry inland areas where soil water and nitrogen can be more effectively manipulated. It is difficult to achieve a result in wetter coastal areas as rain may fall during the vital tree stressing period in April/May.



## Harvesting and marketing

To turn out a quality product, you have to pay particular attention to seven important operations in harvesting and marketing.

Determine maturity .....	35
Harvest .....	35
Treatments before packing .....	38
Grading the fruit .....	41
Pack .....	43
Refrigerate .....	44
Market .....	44

### Determine maturity

Fruit needs to reach a specified maturity standard and juice percentage before it is ready for harvesting. Before you start harvesting, have your fruit tested to make sure it reaches the standard. Testing is done by some citrus cooperatives, private consultants and the DPI Gayndah office. A fee is charged.

### Harvest

Not all the fruit on a tree will mature at the same time. Most varieties will need two or three picks over a six week period. Fruit on the outside of the tree will mature first. Most of the fruit on the skirts and inside the tree will be picked second. A final strip pick may be needed to remove any remaining fruit.

Mandarins and oranges vary with regard to the type of fruit harvested first. For mandarins, take the largest, most coloured fruit at the first pick. This takes the load off the tree and allows the smaller remaining fruit to increase in size. Imperials may need up to three picks. For oranges, size is generally the governing factor. Pickers should always be instructed on what to harvest.

To avoid rind damage, don't pick any fruit when it is wet from dew or rain. Avoid picking fruit in the early morning when the skin is more susceptible to damage. Navels are particularly susceptible to the rind damage condition known as oleocellosis.



To avoid granulation, do not allow fruit to hang on the tree after it is ready for harvesting. Granulation is the drying out of the juice sacks in the fruit mostly at the stem end and is impossible to detect without cutting the fruit. Navel oranges are most affected but it can affect other orange varieties and mandarins, particularly those on rough lemon rootstock.

### Equipment and methods

Fruit may be clipped or plucked from the tree. Plucking is used for all fruit except mandarins. Lift the fruit slightly, twist and snap the fruit downwards. Incorrect technique will cause finger pressure rind damage, stem end bruising, torn skin and 'plugging'.

Clipping is essential for mandarins. Use the specially designed citrus fruit clippers available from citrus cooperatives. Stems should be clipped as short as possible. Don't damage fruit with the clippers.

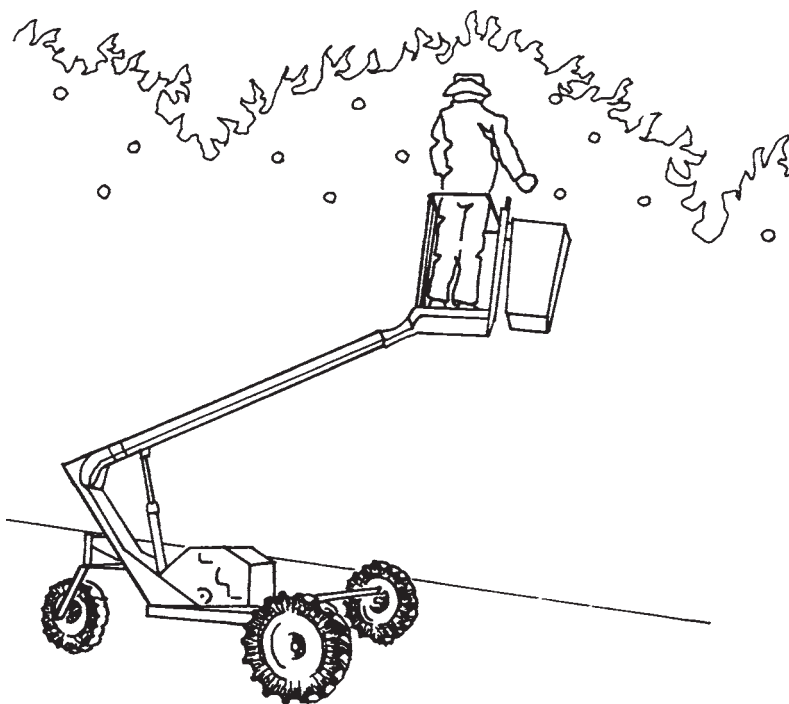
Pickers should keep their fingernails short and wear gloves to protect the fruit as well as their hands. Fruit should never be squeezed.

All fruit which has fallen to the ground should be left there. The risk of fruit rot disease contamination is too high to risk including this fruit with picked fruit.

Light aluminium Bow ladders or three legged ladders (Figure 18) are used to harvest fruit from the tops of trees. Hydraulic picking platforms or cherry pickers are now also commonly used (Figure 19). These are also useful in pruning and thinning operations.

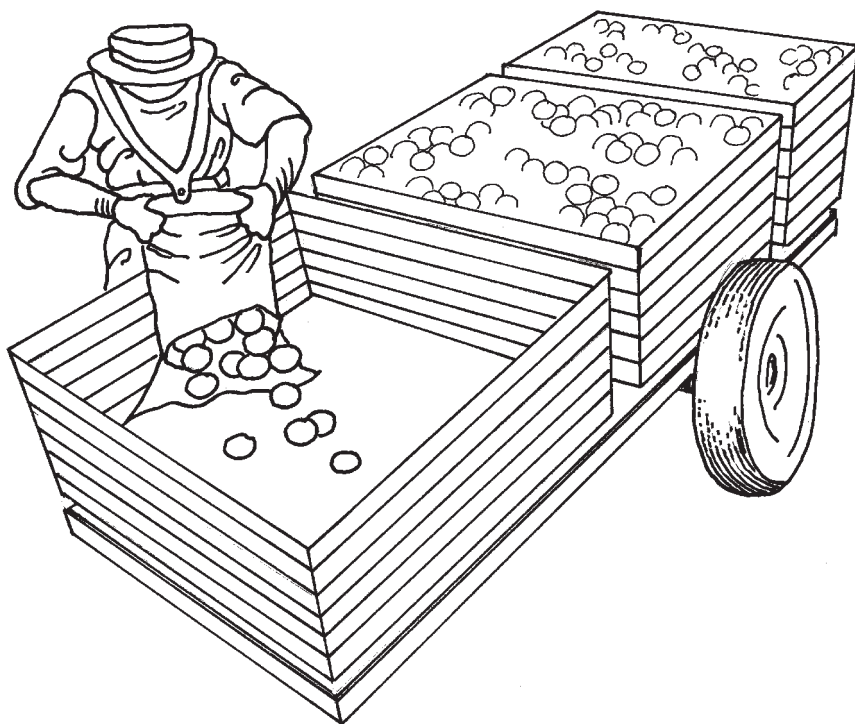


**Figure 18.** Ladders used for picking



**Figure 19.** A cherry picker used for picking and pruning

Commence harvesting at the top of the ladder with an empty picking bag and fill it on the way down. Gently empty fruit from picking bags into half tonne bulk bins for transport to the packing shed by trailer or forklift (Figure 20). Don't drop fruit into an empty bin.



**Figure 20.** Bins used for field harvesting

## Treatments before packing

### Fruit treatment line operation

In Queensland, most treatment lines have a common sequence of operations as illustrated in Figure 21. In many cases, each of the treatment sections is a unit which is easily slotted into the line.

A grower will select which sections to use depending on the market destination. For export, the full line would be used, and for domestic markets, the SOPP treatment is deleted. Interstate quarantine restrictions may require an additional section for a fruit fly treatment. Details of each operation follow.

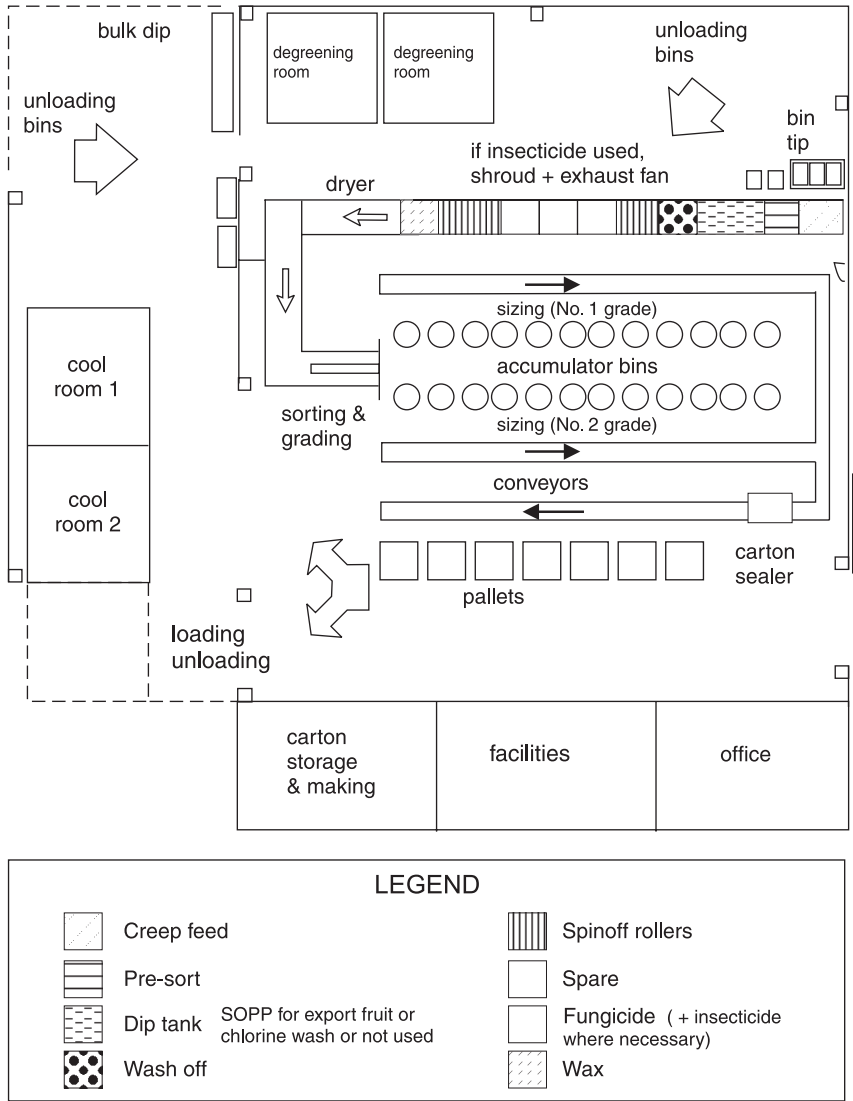


Figure 21. Typical fruit treatment line

### Bulk bin dipping

Dip or flood bulk bins of fruit within 20 hours of harvest with a fungicide to control blue and green mould. If left later than this, moulds will not be controlled effectively. For domestic market fruit,

use the fungicide guazatine (Panocrine). Mix up the dip at a rate of 130 mL/100 L water. Follow label directions. Immerse the fruit for 30 seconds. Top up the dip tank at 260 mL/100L water when the volume in the tank fails to cover the bin of fruit. This treatment does not provide long term protection—it is only to provide protection for the time the fruit are in the shed.

For export fruit, first check the requirements of the importing country as some fungicides are not permitted for export fruit.

### Degreening

Most early varieties (Washington Navel, Imperial, Marisol, de Nules, lemons, grapefruit) mature internally before the rind loses its green colour. This means that fruit must be degreened before marketing. This is done using an airtight room with 'Ripegas' or ethylene gas to break down the chlorophyll in the rind. Room temperatures should be held between 22°C and 25°C and relative humidity at 95%.

Cool rooms may be modified to double as degreening rooms. Since cool rooms are constructed for minimum leakage of heat and air, great care has to be taken in operating them as degreening rooms. Temperature control, maintenance of ethylene concentration, air circulation, ventilation and expulsion of sufficient air are some of the things which need very careful control. The cooling function of the room may be required during the early part of the season to maintain the correct temperatures for degreening.

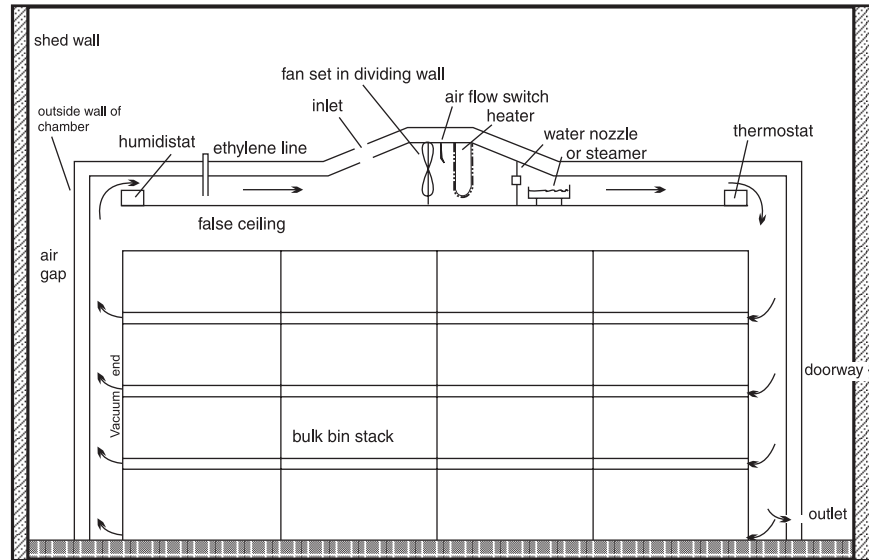


### Degreening methods

Two degreening methods are used:

- The 'Shot Method' uses a single dose of one of the gases three to four times within 24 hours. The room must be ventilated before each new dose. This method takes longer, colouring is uneven and more rind damage may occur.
- The 'Trickle System' is used in modern packing sheds and is the recommended method. A typical room and the necessary pieces of equipment are shown in Figure 22. The best type of room is one made using masonite lining inside and out with a sheet of sisalation in between. The best rooms are located inside a shed with a space between the wall of the shed and the room. The system uses a fan with a minimum capacity of one room volume per minute. This circulates the air in the room, continuously introducing a regulated volume of fresh air and exhausting stale air laden with carbon dioxide. Ethylene is continuously trickled into the room in front of the fan to maintain a gas concentration of 2 to 10 ppm. The system operates automatically. With trickle degreening, fruit degreens faster and fruit colour and quality is superior.





**Figure 22.** Cross section of a typical trickle degreening room

### Fungicide treatment

After degreening, fruit are tipped onto a creep feed and move onto the treatment line for postharvest diseases such as blue and green mould and sour rot.

For export fruit, SOPP is used as the first treatment and is then washed off. SOPP is not normally used on fruit for the domestic market.

As mentioned earlier, the initial Panoptine bulk bin dip provides short term control of diseases while fruit is awaiting packing or going through the degreening process. Fruit must now be given protection for longer periods by further in line treatments of fungicide. These are listed in Table 11. Follow all label directions.

**Table 11.** Postharvest fungicide treatments (for initial mixing rates see Problem Solver Handy Guide)

Fungicide	Trade name	Effective against
carbendazim	Bavistin, Spin	Blue and green mould
thiabendazole	Tecto 90	Blue and green mould, stem end rot
imazilil	Fungaflor, Magnate, Imazgard	Blue and green mould
sodium ortho-phenylphenate (SOPP)	SOPP or Preventol On Extra	Blue and green mould, sour rot

Note:

- For export fruit, remember to first check the requirements of the importing country as some of these chemicals may not be permitted on export fruit.
- Rates for topping up the dip may differ from initial mixing rates. Check the label for details. However, non-recovery systems are preferred.

- The treatment time for SOPP/Preventol On Extra is two minutes and for the others 30 seconds.
- For the SOPP treatment, control of pH of the solution is essential. Follow label directions.

Good control of pests and diseases in the field and maintaining a clean orchard and shed will help take the pressure off the postharvest fungicides. Place all rotten and discarded fruit in containers and remove from the shed daily. Leave no discarded fruit on floors under machinery.

### **Insecticide treatment (if required)**

Where treatment for an insect such as fruit fly is required (see interstate quarantine section), this must be applied as the last treatment and not washed off. It is often included with the fungicide treatment (except for SOPP as it has to be washed off).



Interstate quarantine  
Section 3 page 46

### **Fruit waxing**

Remove surplus moisture from the fungicide treatment before wax is applied. Wax emulsion is best applied as a fine intermittent spray, or as a foam curtain onto the fruit moving over horse hair brush rollers. The foam is produced by bubbling air into the emulsion or beating air into it with a set of rotating paddles. Use wax straight from the container and not diluted with water. A number of suitable natural fruit waxes are available from rural supply stores.

After waxing, fruit passes through a drying tunnel up to 15 metres long to dry the wax. Gas burners and large capacity fans are used in the drier.

## **Grading the fruit**

---

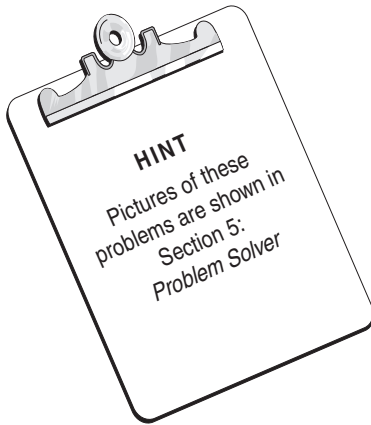
### **Sorting**

Sorting is the most important operation in the packing line and requires knowledge and experience. Fruit comes out of the drier onto the sorting tables. Sorters scan fruit moving past them on rollers. Second grade, juicing and reject fruit are removed and redirected.

Keep a close eye out for the following disorders and discard affected fruit:

#### ***Oleocellosis (Oleo)***

As fruit continue to colour after harvest, damaged areas stay green, but will eventually turn brown. The injury is caused by rind oil liberated from ruptured oil cells onto the skin, damaging surrounding tissue. Damaged cells collapse and sink, leaving the oil cells standing out. Lemons and oranges are the worst affected.



### **Stylar-end rot**

Sometimes called blossom-end rot. A major problem of limes and to a lesser extent lemons. Tissues in the end of the fruit break down causing the rind to split and allowing mould fungi to produce rapid rotting.

### **Lopsided fruit**

Mostly a problem in Ellendale mandarins. Fruit are distorted in shape from uneven growth.

### **Creasing**

Discard badly creased fruit as any pressure on the creased area can cause a split during transport. This is a prime site for the entry of moulds which may develop rapidly and infect adjacent fruit in the carton.

### **Fruit splitting**

Mostly a problem in Navels, Ellendales and Murcotts. Tiny splits originate at the navel end where the rind is thinnest.

### **Grading**

As most export markets have set minimum standards for fruit entering their markets, grade to these standards. It is always preferable to have standards that are above the set minimums. For some export markets, there are manuals illustrating the different levels of blemish and other defects allowable. Supply of this material is the responsibility of the individual packing shed operator.

There are currently no legal grade standards in force for the domestic market. Each grower should set their own minimum grade standards. If you don't know where to start, negotiate a set of desired standards with your intended market.

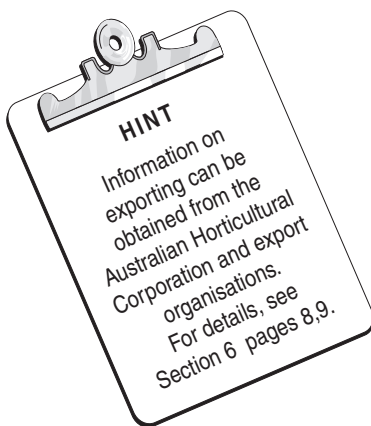
As a guide, the previous general standards can be used. These use three grades or classes—Extra Class, Class 1 and Class 2. The broad standards are:

#### **Extra Class**

- typical of the variety
- practically free from defects and blemishes
- free from pest and disease damage
- free from disorders and puffiness
- free from irregular greening

#### **Class 1**

- typical of the cultivar
- reasonably free from defects as long as those defects:



- \* are natural to the cultivar
- \* are slight mechanical blemish which is healed
- \* don't affect the keeping quality
- \* do not exceed 1.5 sq cm in area (the size of a one cent piece)
- \* do not affect presentation
- primarily free from pest and disease damage
- free from disorders
- free from puffiness

**Class 2** is of slightly lesser quality than Class 1, allowing defects in shape, and blemishes as long as these don't affect keeping quality. Other problems such as detachment of the rind are also allowed in this Class.

## Sizing

Fruit is separated into different size categories by passing it through either belt-and-roller sizing machines or electronic sizing machines. Generally accepted minimum sizes are shown in Table 12.

**Table 12.** Minimum size diameter of fruit

Fruit	Size (mm)
Limes	25
Lemons, mandarins and tangors	45
Oranges	53
Grapefruit	70

Within any size category, a tolerance of 2 mm below and 4 mm above is generally accepted.

## Stickers

Some growers use electronic equipment to place individual stickers on Extra Class or Class 1 fruit for clear identification in the marketplace.

## Pack

### Packages

Citrus is marketed in many different containers. Most citrus is sold in fibreboard cartons which hold either 9 to 10 kg (half citrus pack) or 18 kg (citrus pack). Limes are generally marketed in 9 L cartons containing about 5 kg of fruit. These are sometimes referred to as ¼-cartons. Both one piece and two piece cartons are used. The inner and outer of two piece cartons can be stapled or glued.

Citrus are packed using either standard pattern packing or volume fill methods. Most are pattern packed but many Imperials are volume filled. Bulk fruit is sent in either heavy fibreboard containers containing 200 to 300 kg per pallet or larger steel or wooden bins containing up to 450 kg.

## Carton marking (trade description)

The following information must be PRINTED or STAMPED (not hand written) on the end of the carton.

ORANGES			
Packed by:	<b>IMA GOODGROWER PRICKLE FARM GONDWANALAND Q</b>		
Variety	Class	Count	Size
<b>W. NAVEL</b>	<b>1</b>	<b>88</b>	<b>70 MM</b>

The fruit count must be in letters at least 4.8 mm high. Other markings must be readily visible and legible.

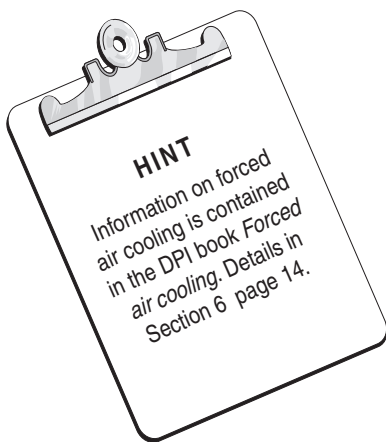
Export cartons will also need an export packing shed number and the name of the exporter. For the full marketing requirements, purchase a copy of the *Citrus Export Standards* from the Commonwealth Book Store, Adelaide St, Brisbane.

## Refrigerate

After packing, rapidly precool fruit before shipment to market. This minimises rots and extends shelf life. Cool the fruit to 7 to 10°C as soon as possible after packing. A high humidity forced air cooling system is recommended. If fruit is to be stored for any length of time, further cool to 5°C to 7°C.

Fruit for the Perth market must be precooled and carried in refrigerated trailers.

Fruit for export must be cooled to a minimum of 10°C before loading into the container which will then cool and maintain the temperature at around 5°C for the whole journey. Check the temperature requirements for different varieties.



## Market

### Transport

Over 90% of the State's fresh fruit is transported to markets by road. Most trailers carry 20 pallets of fruit. There is an increasing number of tautliners and refrigerated trailers. Some are tarp covered. Only processing fruit is transported by rail from country areas to the cannery in Brisbane.

### Marketing

There are many options for how you can market your fruit. Here are the main ones.



Marketing  
Section 4 page 63



more info

Marketing groups  
Section 6 page 7

- Domestic capital city produce markets.** Most Queensland citrus is sold fresh in major capital city produce markets. Fruit is consigned to wholesale agents who sell your fruit on commission keeping a percentage of the proceeds for their service. Most Queensland citrus is consigned to the Brisbane, Sydney and Melbourne markets but smaller quantities go to all state capitals. Wholesale agents are in effect your source of market intelligence. For this reason, the choice of a wholesale agent is extremely important. It is best to deal only with a specialist citrus wholesaler. Seek advice on selecting wholesale agents from local growers in your area. Market authorities in each wholesale market have booklets covering market times and rules along with a list of agents and merchants operating in their market. Also remember that you must meet the quarantine requirements defined by each state.
- Export.** Exporting of mandarins and oranges is well established, although this accounts for only 10 to 15% of total production. Export destinations include Canada, South-East Asia, Japan, the Middle East and Europe. Export has complex and specialised requirements and is normally only available to large growers or marketing groups or cooperatives. It requires strict attention to quality standards and quarantine requirements. For example, the Japanese market has a nil tolerance for black spot and fruit fly. Fruit must be subjected to a cold disinfestation treatment, which demands that fruit be kept at 0°C for 16 days. A Japanese inspector must be present for this procedure and the stuffing of the shipping container. Growers pay all costs.
- Marketing groups or cooperatives.** Join a marketing group or cooperative where fruit may be jointly packed and marketing decisions are made on a group basis. This is highly recommended as the combined resources and volume of product allow a greater range of marketing opportunities to be explored. It gives individual growers much more marketing power. Existing co-operatives/ marketing groups are located in the Central Burnett and on the Sunshine Coast.
- Sell direct to major city chain stores and fruit barns.** These outlets require a regular supply of uniform quality fruit. This is only an option for either very large farms or marketing cooperatives.
- Local supply.** In the more populated areas, you may wish to organise direct supply to local district retailers. This can be hard work and the costs of organising sales and distributing fruit need to be carefully considered. With specialised products such as limes, there is also the possibility of direct supply to resorts and restaurants. Where you have good passing traffic, you can also sell fruit on the farm or at a roadside stall. Small growers in tourist areas with good road access may even consider a 'pick-your-own' operation. Check on local authority requirements for signs and parking and take out public liability insurance.

more info



Citrus processors  
Section 6 page 8

- **Processing.** The Golden Circle Cannery in Brisbane is a major processing outlet. Fruit in large quantities is also processed by Tropico Pty Ltd at Palmwoods and by Central Burnett Fruit Processing Cooperative at Mundubbera. Many small processors are manufacturing a range of juice products and there is increasing use of in-store juicing machines. Many coastal growers rely heavily on processing because of the excessive rind blemishing caused by humid coastal growing conditions. Drier inland areas produce a relatively low percentage of fruit for processing.

Whatever market outlet you choose, keep in close contact with your marketer and ask for feedback on the quality of your fruit in the marketplace. Regularly visit the major markets in which your fruit is sold.

## Interstate movement provisions

### *Papaya fruit fly*

At present special restrictions apply to the movement of citrus out of the Papaya Fruit Fly Quarantine Zone to all other areas of Australia. If you are located within this zone, your fruit must meet one of the issued Certification Assurance arrangements for movement interstate or to other parts of Queensland. Check current regulations with your local DPI inspector. Otherwise, there are no restrictions on the movement of citrus fruit within Queensland.

Other restrictions for shipment to other states are:

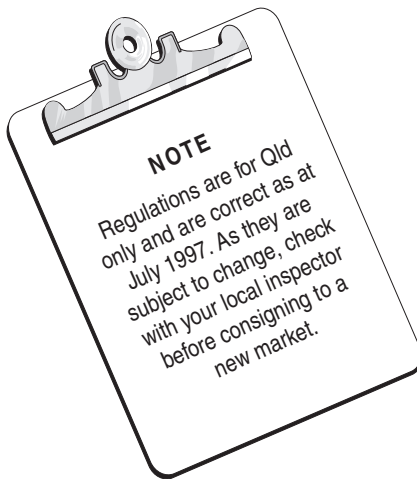
### *New South Wales*

- No restriction into most areas of NSW. Fruit not permitted into the Fruit Fly Exclusion Zone of MIA, Sunraysia and the mid-Murray area.

### *Victoria*

There are a number of options:

- Fruit must be dipped or flood sprayed in either dimethoate at a concentration of 400 ppm or fenthion at a concentration of 412.5 ppm. Dipping must be for one minute and flood spraying at a rate of 16 L per square metre per minute for a minimum of 10 seconds with the fruit remaining wet for a further 60 seconds. The treatment must be the last treatment before packing except where wax is applied. All dipping facilities must first be registered with the Victorian authorities through DPI. An approved grower declaration form must accompany each consignment. In time, fruit will need to be treated, packed and certified under the Interstate Certification Assurance Scheme.
- Specified fumigation treatment with methyl bromide. This may only be done in registered and tested chambers operated by an



authorised fumigator. Growers using this option also need to be registered with the Victorian authorities through DPI. An approved grower declaration form must also accompany each consignment.

- Specified cold storage treatment for grapefruit, lemons and oranges. Growers using this option must be registered with the Victorian authorities through DPI. An approved grower declaration form must also accompany each consignment.
- For Tahitian Limes, an alternative is that fruit must be harvested and packed in a mature-green condition. Growers using this option must be registered with the Victorian authorities through DPI. An approved grower declaration form must also accompany each consignment.



### **South Australia**

There are a number of options:

- Fruit must be dipped or flood sprayed in either dimethoate at a concentration of 400 ppm, or fenthion at a concentration of 412.5 ppm. Dipping must be for one minute and flood spraying at a rate of 16 L per square metre per minute for a minimum of 10 seconds with the fruit remaining wet for a further 60 seconds. The treatment must be the last treatment before packing except where wax is applied. Treatment must be carried out under supervision of a DPI inspector.
- Specified fumigation treatment with methyl bromide. This may only be done in registered and tested chambers operated by an authorised fumigator and must be supervised and certified by a DPI inspector.
- Specified cold storage treatment for grapefruit, lemons and oranges. Certification by a DPI inspector is required.



### **Western Australia**

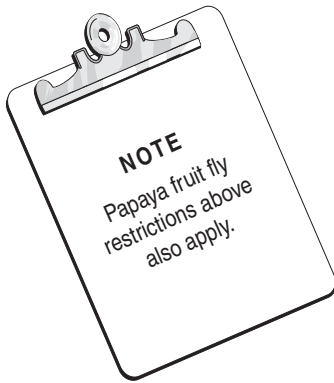
There are a number of options:

- Fruit must be dipped or flood sprayed in either dimethoate at a concentration of 400 ppm, or fenthion at a concentration of 412.5 ppm. Dipping must be for one minute and flood spraying at a rate of 16 L per square metre per minute for a minimum of 10 seconds with the fruit remaining wet for a further 60 seconds. The treatment must be the last treatment before packing except where wax is applied. Treatment must be carried out under supervision of a DPI inspector.
- Specified fumigation treatment with methyl bromide. This may only be done in registered and tested chambers operated by an authorised fumigator and must be supervised and certified by a DPI inspector.



- Specified cold storage treatment for grapefruit, lemons and oranges. Certification by a DPI inspector is required.

In addition, a special certification is required that the citrus fruit are free from European red mite and melon thrips. Tahitian limes must also be certified as having been harvested in a mature-green condition. These certifications are generally supplied by the inspector in conjunction with the other treatments.



### **Tasmania**

- Specified fumigation treatment with methyl bromide. This may only be done in registered and tested chambers operated by an authorised fumigator and must be supervised and certified by a DPI inspector.
- Specified cold storage treatment for grapefruit, lemons and oranges. Certification by a DPI inspector is required.

### **Northern Territory**

- No restrictions except for Papaya fruit fly provisions above.

### **Quality management**

Although most domestic markets do not currently demand quality assured fruit, quality assurance is becoming an important part of marketing and will be demanded more in the future. Part of this requirement will be to meet the needs for 'safe food standards' which are being demanded by more and more consumers. Domestic markets and importing countries may soon demand assurances for best practices in all sections of the industry. It is important to be ready for this when it comes and start now to develop a quality management system at the farm level. This will be an added cost, but you should be able to achieve a premium price and increased profitability by being able to supply a product that the market wants.

The best way of getting into quality management is to join one of the marketing groups or cooperatives that have quality assurance schemes. If this option is unavailable, some information to get you started is in Section 4 of this kit.




---

Marketing  
Section 4 page 63

---




---

Marketing groups  
Section 6 page 7

---